

LAMPIRAN A

MANUAL MOBILF COMPACTUS - 6 BAYS
6BMC15

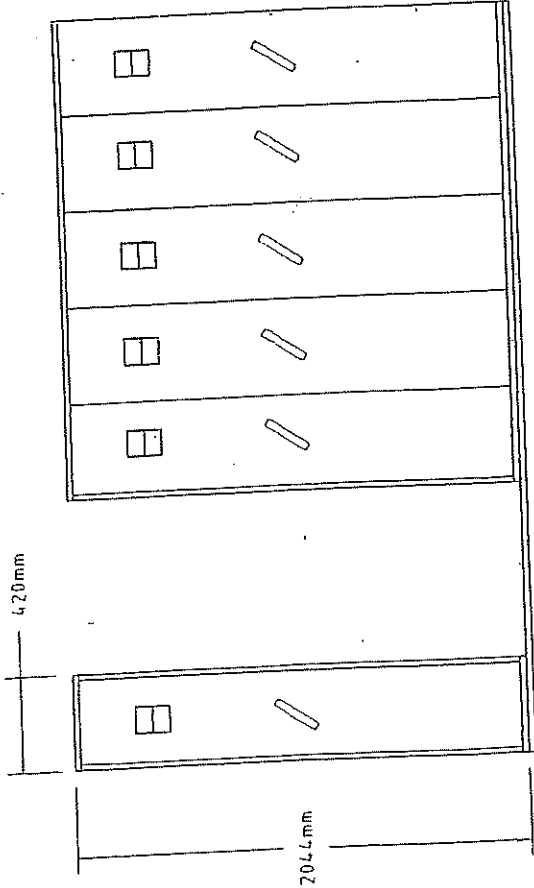
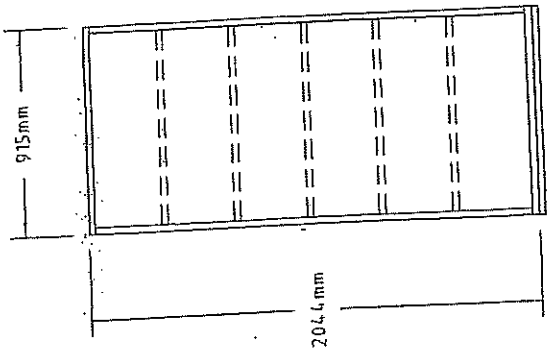
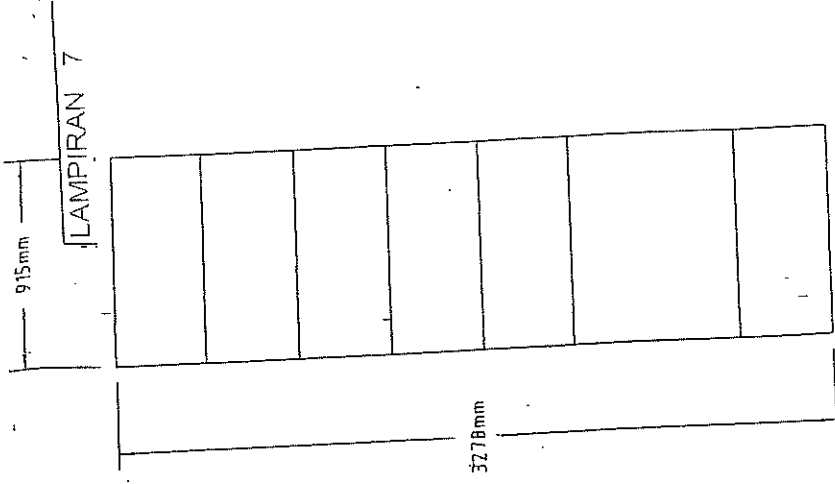

PANDANGAN ATAS

PANDANGAN TEPI

PANDANGAN DEPAN

CATATAN:	SPESIFIKASI BAHAN		TARIKH	OLEH	SMK.
	KEPINGAN LOGAM 0.65/0.8 /Z.0MM				
SEMUA STRUKTUR DILAPIS "EPOXY"					1
					2
					3
					4
					5
TAJUK: MANUAL MOBILF COMPACTUS - 6 BAYS (6BMC15)					
NO. LUKISAN:					
NO. FAIL:					
SKALA: BEBAS					
OVERAL SIZE: W915 X L3278mm SIZE PER BAY: W915 X D419mm WALKING AREA: W762mm					
ANGGARAN +0.1 / -0.3					

LAMPIRAN 8

FULL HEIGHT OPEN DOOR CUPBOARD c/w 3 SHELVES
FH016

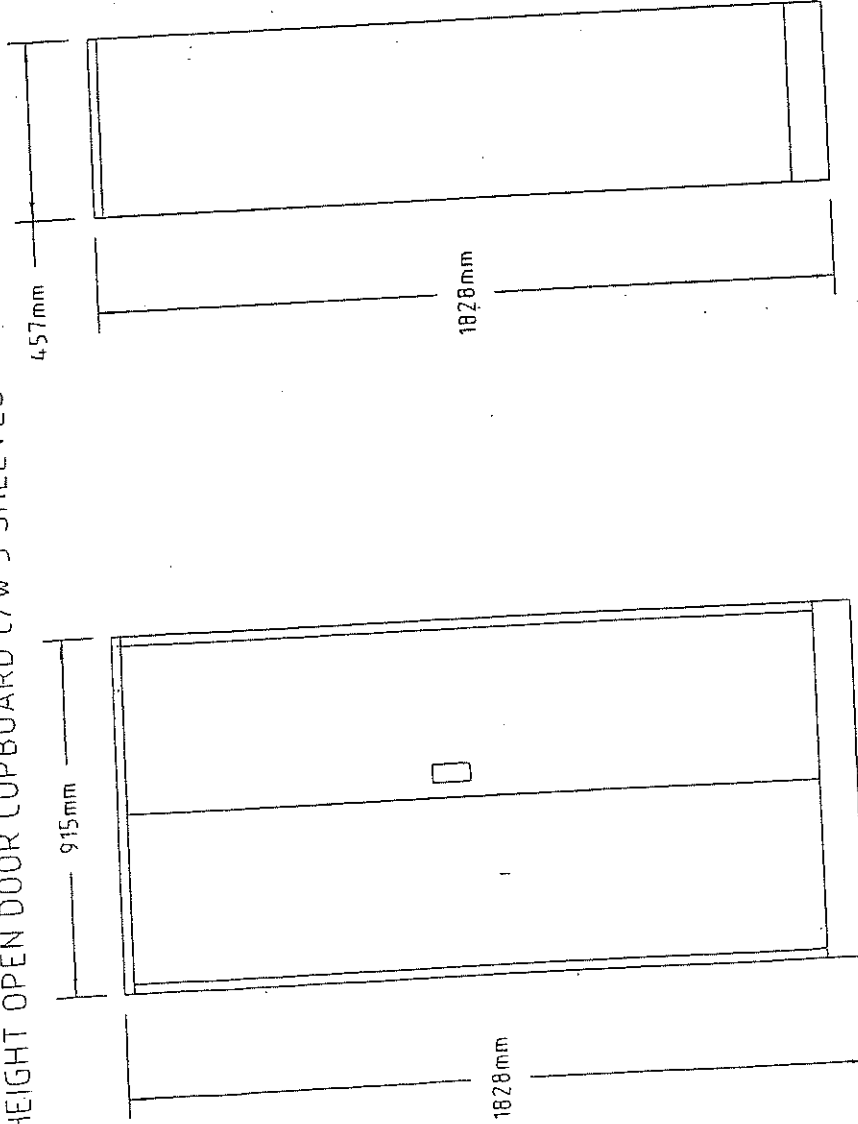

PANDANGAN ATAS

PANDANGAN SISI

PANDANGAN DEPAN

PANDANGAN DEPAN		PANDANGAN SISI	
CATATAN:	SPEKIFIKASI BAHAN	TARIKH	OLEH
SEHUA STRUKTUR DILAPISI "EPOXY"	KEPINGAN LOGAM 0.65/0.8/2.0MM	1	SMK
		2	
		3	
		4	
		5	
UKURAN : W915 X D457 X H1828mm		ANGGARAN +0.1 / -0.3	

TAJUK:
FULL HEIGHT OPEN DOOR CUPBOARD c/w 3 SHELVE
(FH016)

NO. LUKISAN:
NO. FAIL:

SKALA:
BEBAS

FULL HEIGHT SLIDING DOOR CUPBOARD c/w 3 SHELVES

FHS17

LAMPIRAN 9

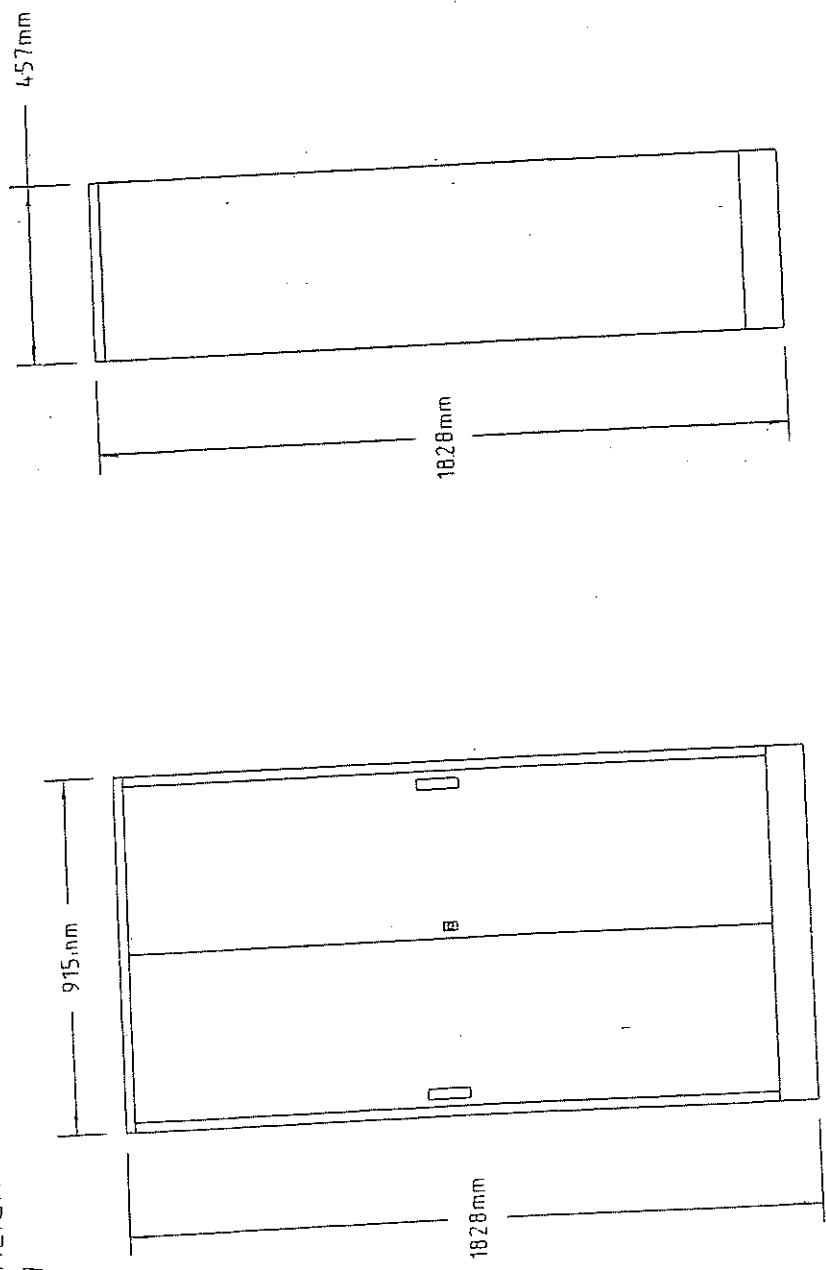

PANDANGAN ATAS

PANDANGAN SISI

PANDANGAN DEPAN

PANDANGAN DEPAN		PANDANGAN SISI	
CATATAN:	SPEKIFIKASI BAHAN	TARIKH	OLEH
SEMUA STRUKTUR DILAPISI "EPOXY"	KEPINGAN LOGAM 0.65/0.8/2.0MM	1	SMK.
		2	
		3	
		4	
		5	
UKURAN: W915 X D457 X H1828mm	ANGGARAN +0.1 / -0.3		

TAJUK:
FULL HEIGHT SLIDING DOOR CUPBOARD C/W 3 SHELVES (FHS17)

NO. LUKISAN:
NO. FAIL:

SKALA:
BEBAS

SINGLE COMPUTER TABLE
SCT35

LAMPIRAN 20

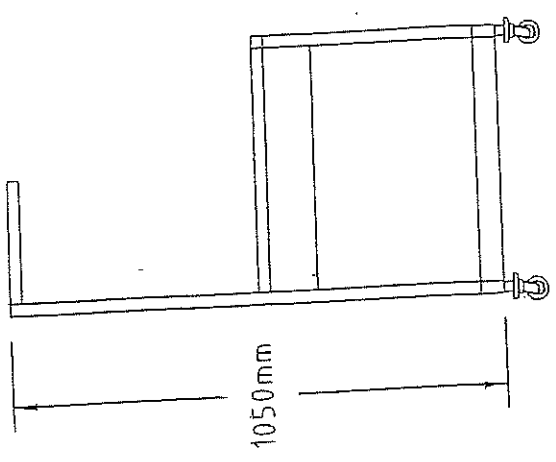
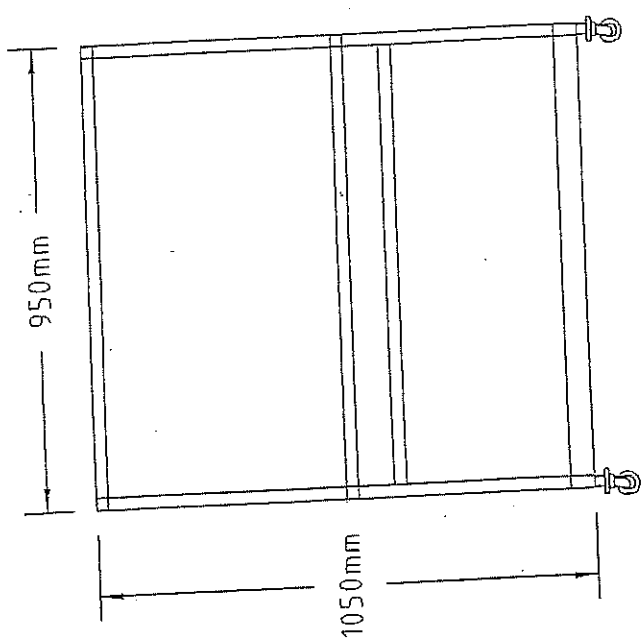
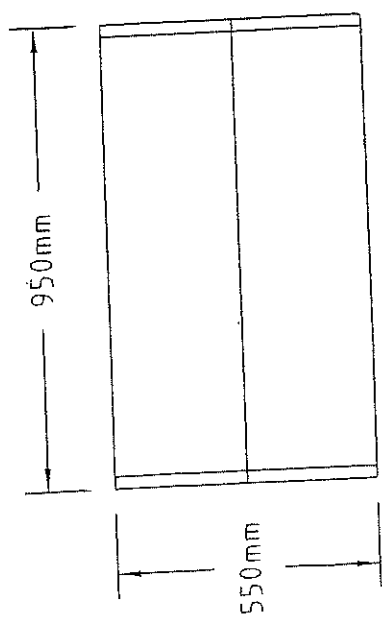

CATATAN: SEMUA STRUKTUR DILAPISI "EPOXY"	SPESIFIKASI BAHAN		TARIKH	OLEH	SMK.	TÁ JUK: SINGLE COMPUTER TABLE (SCT35)	SKALA: BEBAS
	KEPINGAN LOGAM 0.65/0.8/2.0MM						
UKURAN : L950 X D550 X H1050mm	PANGGARAN +0.1 / -0.3					NO. FAIL:	

DOUBLE PEDESTER DESK - 7 DRAWERS
7DP37

LAMPIRAN 21

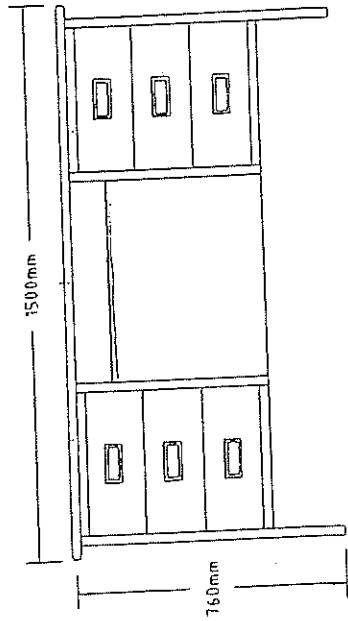

PANDANGAN DEPAN

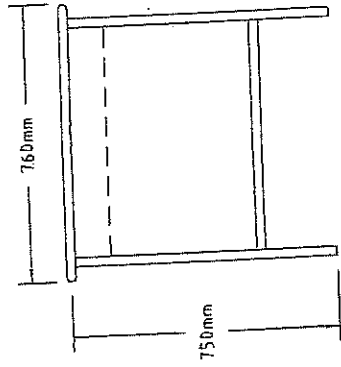

PANDANGAN SISI

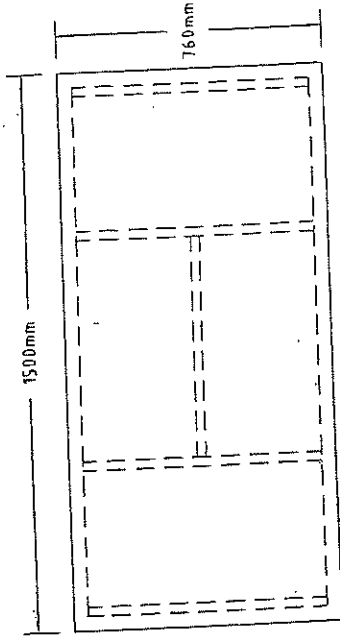

PANDANGAN ATAS

UKURAN : W150 X D760 X H760mm
CHIPBOARD HIGH PRESSURE LAMINATE
POST - FORMED TOP

CATATAN:	SPESIFIKASI BAHAN		TARIKH	OLEH	SMK.
	1	2			
SEMUA STRUKTUR DILAPISI "EPOXY"	KEPINGAN LOGAM 0.65/0.8/2.0MM				1
					2
					3
					4
					5
TAJUK: DOUBLE PEDESTER DESK - 7 DRAWERS (7DP37)					
NO. LUKISAN:					
NO. FAIL:					
SKALA: BEBAS					
UKURAN : W391 X D385 X H1828mm	ANGGARAN +0.1 / -0.3				

SINGLE PEDESTAL DESK - 4 DRAWERS
4DSP38

LAMPIRAN 22

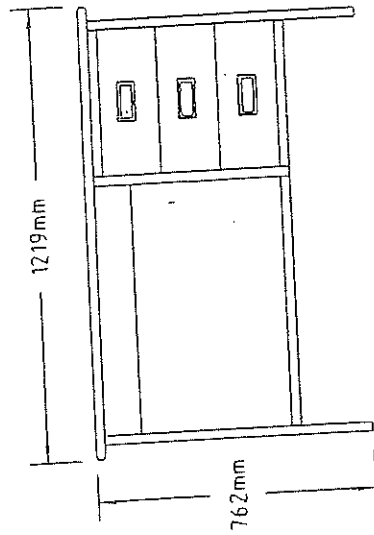

PANDANGAN DEPAN

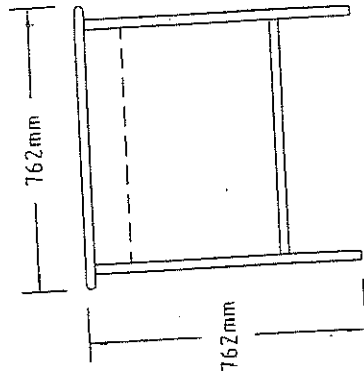

PANDANGAN SISI

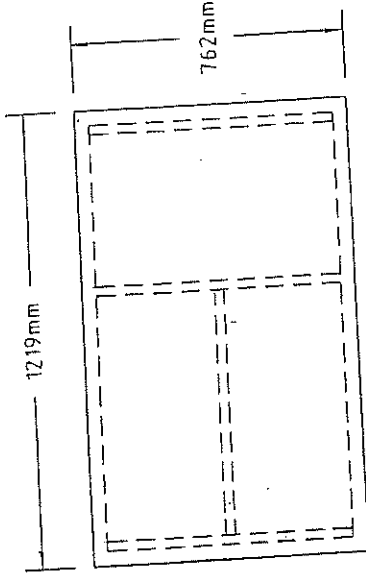

PANDANGAN ATAS

CATATAN:		TARIKH	OLEH	SMK.
SEMUA STRUKTUR DILAPISI "EPOXY"	SPESIFIKASI BAHAN KEPINGAN LOGAM 0.65/0.8/2.0MM			1
				2
				3
				4
				5
UKURAN: W1200 X D760 X H760mm		ANGGARAN -0.1 / -0.3		
TAJUK: SINGLE PEDESTAL DESK - 4 DRAWERS (4DSP38)		NO. LUKISAN:		SKALA: BEBAS
		NO. FAIL:		

WRITING TABLE C/W MELAMINE TOP,
MOBILE PEDESTAL & COMPUTER TRAY.
WT40

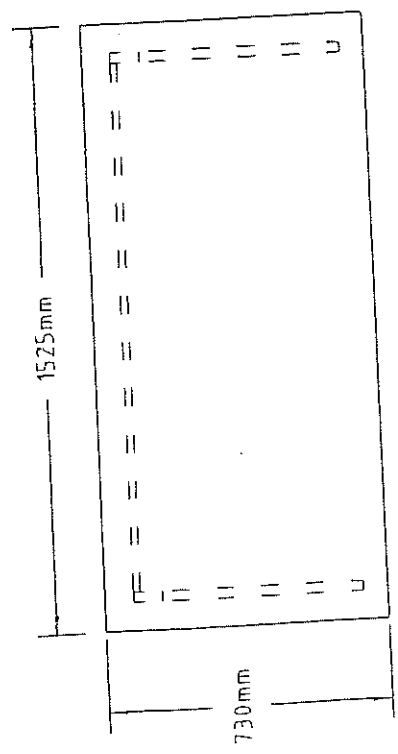

PANDANGAN ATAS

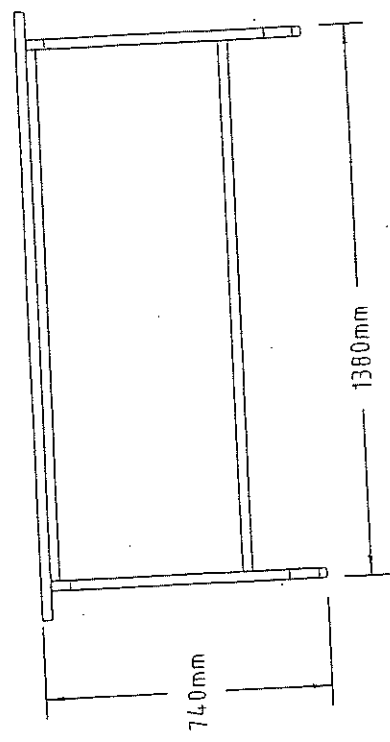

PANDANGAN HADAPAN

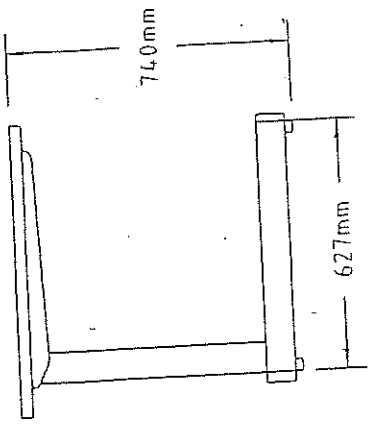

PANDANGAN SISI

CATATAN:	SPESIFIKASI BAHAN		TARIKH	OLEH	SMK.
	KEPINGAN LOGAM 0.65/0.8/2.0MM				
SEMUA STRUKTUR DILAPISI "EPOXY"					
UKURAN : L1500 X D760 X H760mm	ANGGARAN -0.1 / -0.3				
TAJUK: WRITING TABLE C/W MELAMINE TOP (WT40)					
NO. LUKISAN:					
NO. FAIL:					
SKALA: BEBAS					

WRITING TABLE C/W MELAMINE TOP
 CENTER DRAWER & HANGING 2 DRAWER
 PEDESTAL
 WT41

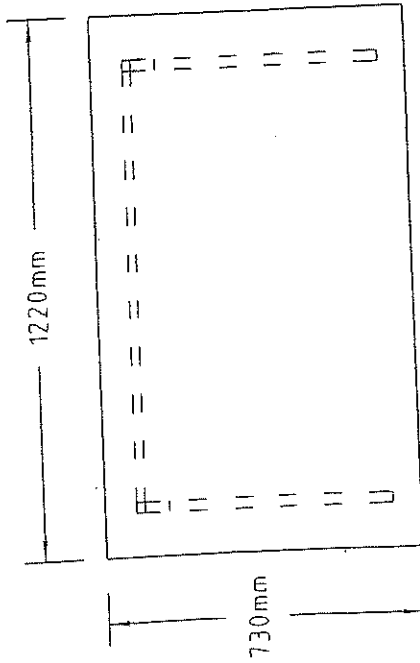

PANDANGAN ATAS

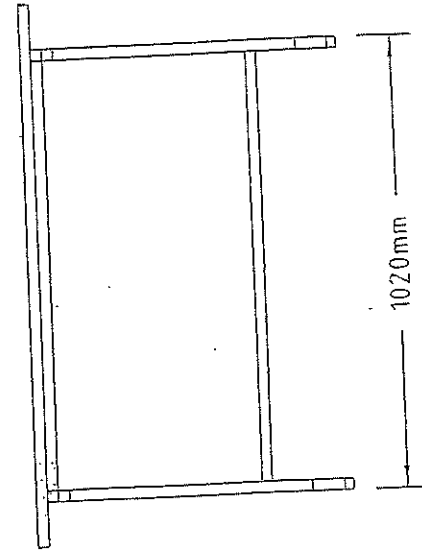
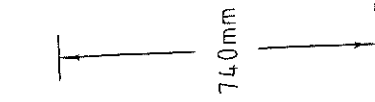

PANDANGAN HADAPAN

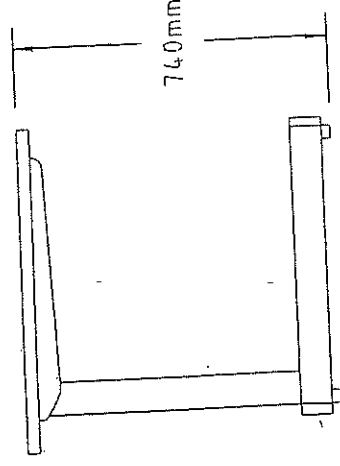

PANDANGAN SISI

CATATAN:	SPESIFIKASI BAHAN				
	TARIKH	OLEH	SMK.		
SEMUA STRUKTUR DILAPISI "EPOXY"			1		
			2		
			3		
			4		
			5		
TAJUK: WRITING TABLE C/W MELAMINE TOP (WT41)					SKALA: BEBAS
UKURAN : L1200 X D760 X H760mm					ANGGARAN -0.1 / -0.3

FOLDAWAY RECTANGLE TABLE (A)
FRT42

LAMPIRAN 25

PANDANGAN ATAS

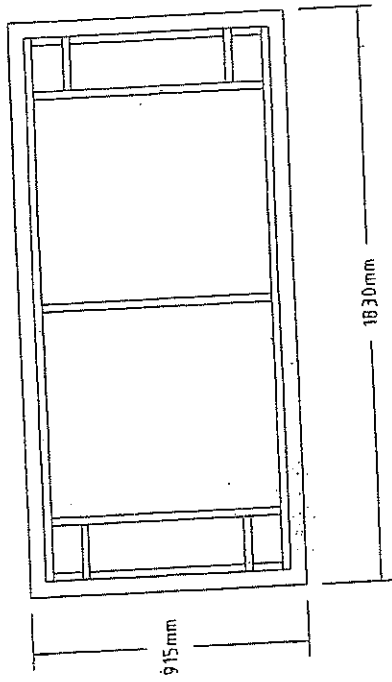

PANDANGAN SISI

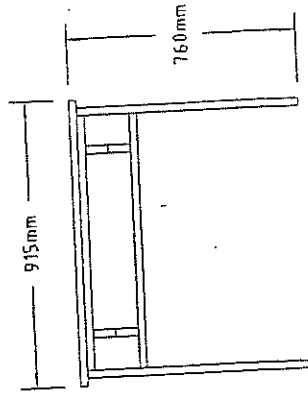

PANDANGAN DEPAN

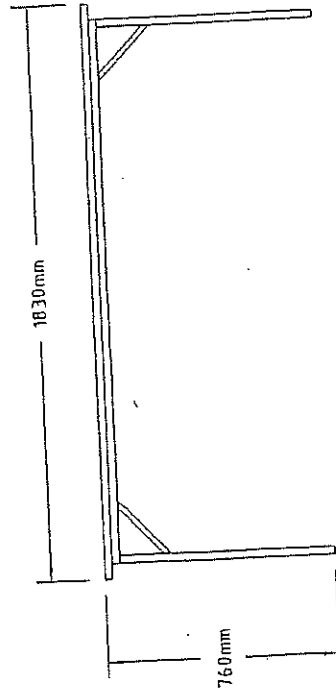

TABLE TOP: MAICA LAMINATED TOP
C/W PU EDGING
LEG BASE: MILDSTEEL BLACK EPOXY
COLLAPSIBLE BASE

CATATAN:	SPESIFIKASI BAHAN		TARIKH	OLEH	SMK.
	Kepingan Logam 0.65/0.8/2.0MM				
SEMUA STRUKTUR DILAPISI "EPOXY"					1
					2
					3
					4
					5
UKURAN : W915 X D1830 X H760mm	ANGGARAN +0.1 / -0.3				

TAJUK:
FOLDAWAY RECTANGLE TABLE (A) (FRT42)

NO. LUKISAN:
NO. FAIL:
SKALA:
BEBAS

FOLDAWAY RECTANGLE TABLE (B)
FRT43

LAMPIRAN 26

PANDANGAN ATAS

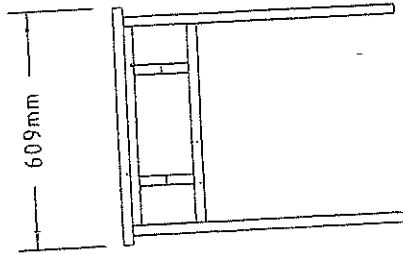
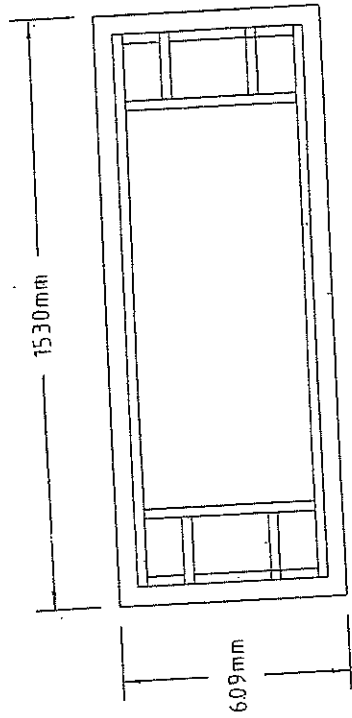

PANDANGAN SISI

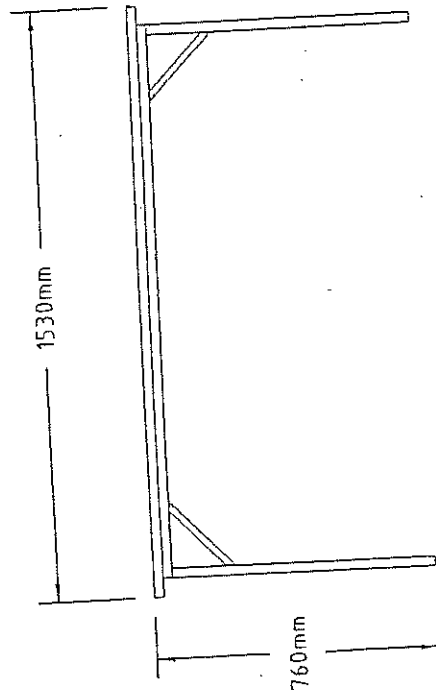

PANDANGAN DEPAN

TABLE TOP: MAICA LAMINATED TOP
C/W PU EDGING
LEG BASE: MILDSTEEL BLACK EPOXY
COLLAPSIBLE BASE

CATAHAN:	SPESIFIKASI BAHAN		TARIKH	OLEH	SMK.
	SEMUA STRUKTUR DILAPISI "EPOXY"	KEPINGAN LOGAM 0.65/0.8/2.0MM			
UKURAN : W609 X D1530 X H760mm	ANGGARAN +0.1 / -0.3				1
					2
					3
					4
					5

TAJUK:
FOLDAWAY RECTANGLE TABLE (B) (FRT43)

NO. LUKISAN:
SKALA:
BEBAS

NO. FAIL:

OFFICER WARDROBE
OW47

LAMPIRAN 27

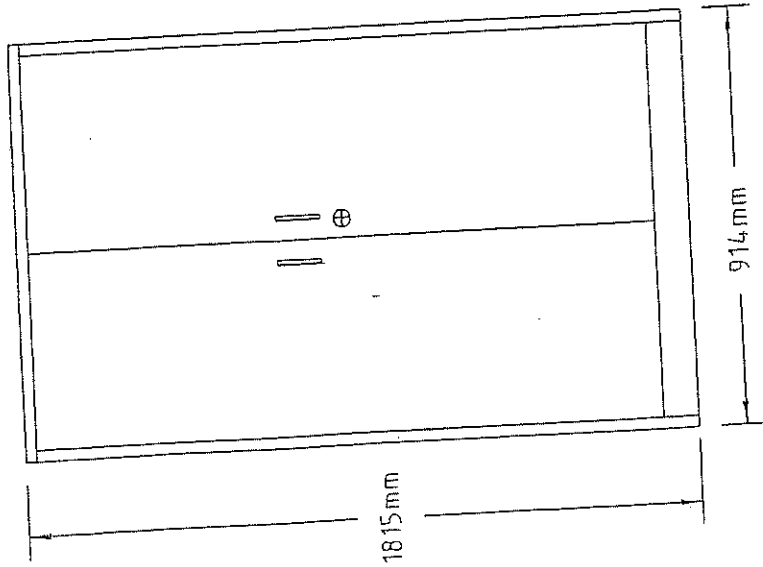

PANDANGAN HADAPAN

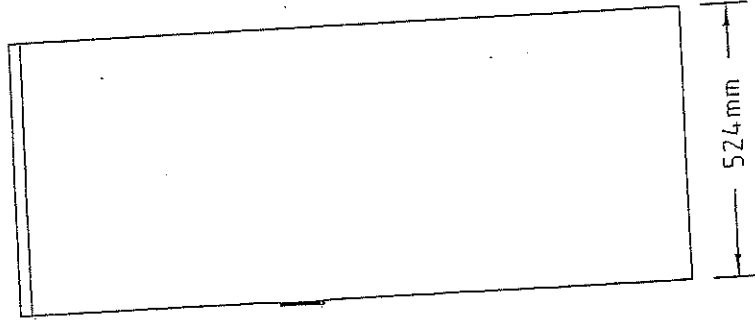

PANDANGAN SISI

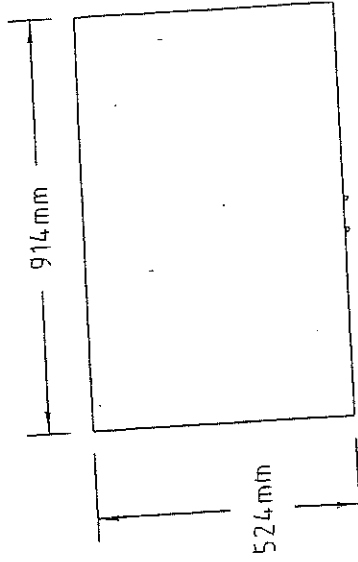

PANDANGAN ATAS

CATATAN:		SPESIFIKASI BAHAN		TARIKH	OLEH	SMK.
SEMUA STRUKTUR DILAPISI "EPDXY"		KEPINDAN LOGAM 0.65/B.B/Z.0MM				1
						2
						3
						4
						5
TAJUK: OFFICER WARDROBE (OW47)						
NO. LUKISAN:						
NO. FAIL:						
SKALA: BEBAS						
UKURAN : W524 X D914 X H1815mm		RANGKAIAN +0.1 / -0.3				

LAMPIRAN 30

LAMPIRAN 30

PANDANGAN ATAS

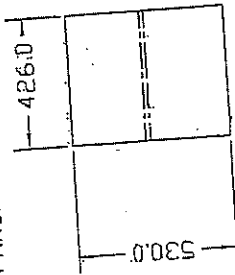

TRAINEE LOCKER TL51

TIUB PENYIDAL

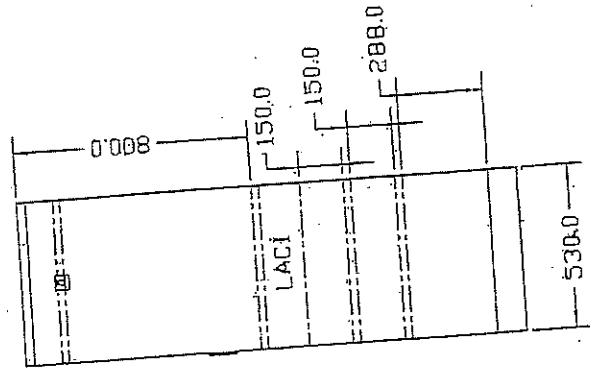
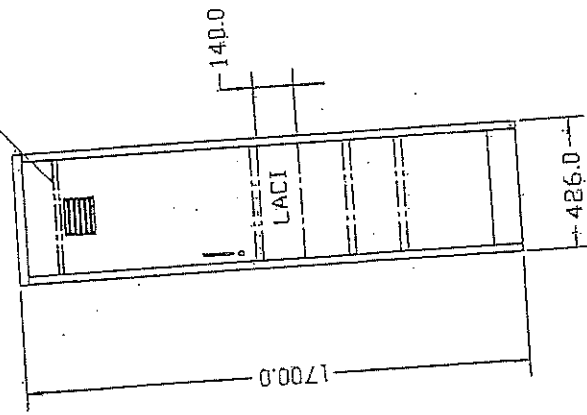

PANDANGAN SISI

PANDANGAN HADAPAN

- AKSESORI
- SKRU & NUT 1" - 4 UNIT
- "CAH LOCK" - 1 UNIT
- TOMBOL PINTU - 1 UNIT
- ENSEL - 3 UNIT

CATATAN	SPESIFIKASI BAHAN	TARIKH	OLEH	SMK	TAJUK		SKALA
					NO. LUKISAN	NAMA FAIL	
	KEPINGAN LOGAM 0.65MM, 1.25MM & 2.0MM			1		TL51	
	TIUB BULAT 19MM			2			
				3			
				4			
				5			
SEMUA UKURAN DALAM MM	ANGGARAN +0.1 / -0.0						
KECUALI DINYATAKAN							

3 TIERS LETTER RACK
3LR58

LAMPIRAN 34

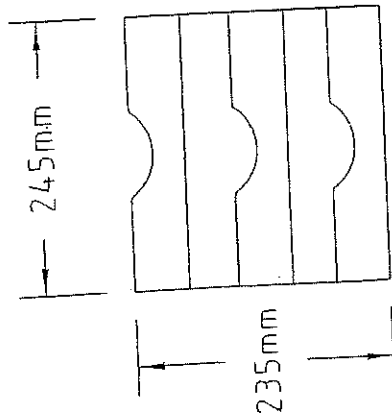
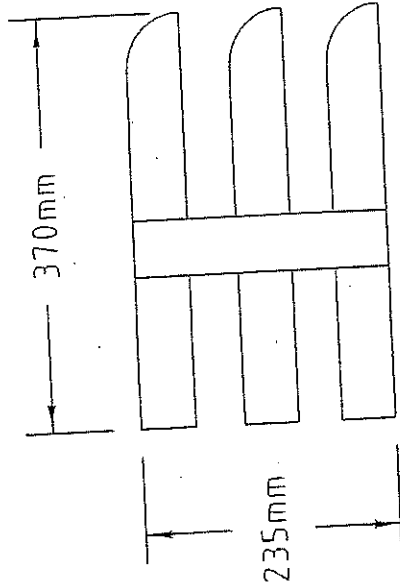
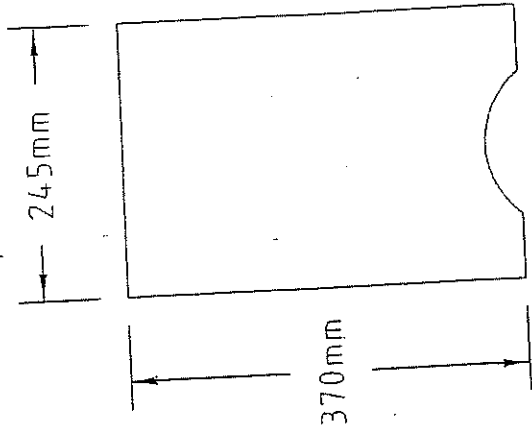

PANDANGAN ATAS

PANDANGAN SISI

PANDANGAN DEPAN

CATATAN:	SPESIFIKASI BAHAN		TARIKH	OLEH	SHK.
	KEPINGAN LOGAM 0.65/0.8/2.0MM				
SEMUA STRUKTUR DILAPISI "EPOXY"					1
					2
					3
					4
					5
UKURAN: W245 X D370 X H235mm	ANGGARAN +0.1 / -0.3				
TAJUK: 3 TIERS LETTER RACK (3LR58)					
ND. LUKISAN:					
SKALA: BEBAS					
ND. FAIL:					

SIDE TABLE C/W 9 HOLES
9HST63

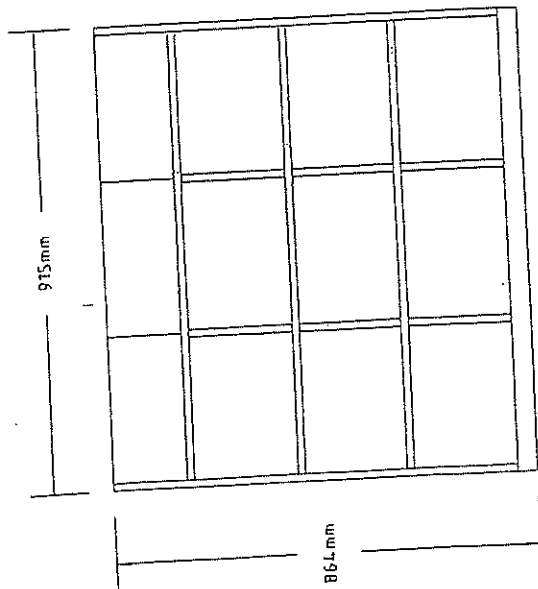

PANDANGAN DEPAN

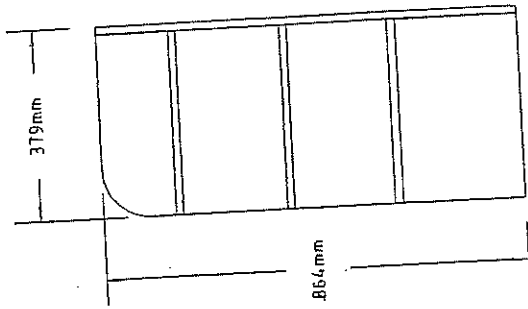

PANDANGAN SISI

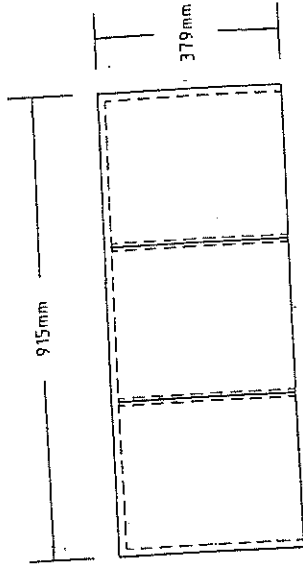

PANDANGAN ATAS

CATATAN:	SPESIFIKASI BAHAN		TARIKH	OLEH	SMK.
	KEPINGAN LOGAM 0.65/0.8/2.0MM				
SEMUA STRUKTUR DILAPISI "EPOXY"					1
					2
					3
					4
					5
T.AJUK: SIDE TABLE C/W 9 HOLES (9HST63)					
NO. LUKISAN:					
NO. FAIL:					
SKALA: BEBAS					
UKURAN: W915 X D379 X H864mm		ANGGATAN +0.1 / -0.3			

BOOK TROLLEY WITH FLATE SHELVES BTF64

LAMPIRAN 37

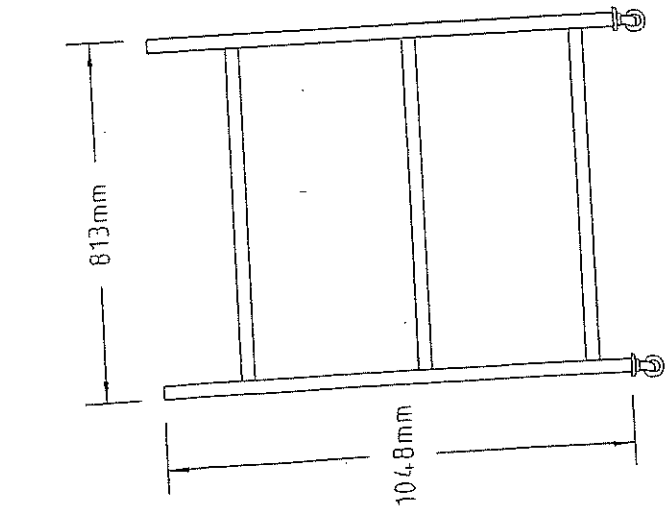

PANDANGAN DEPAN

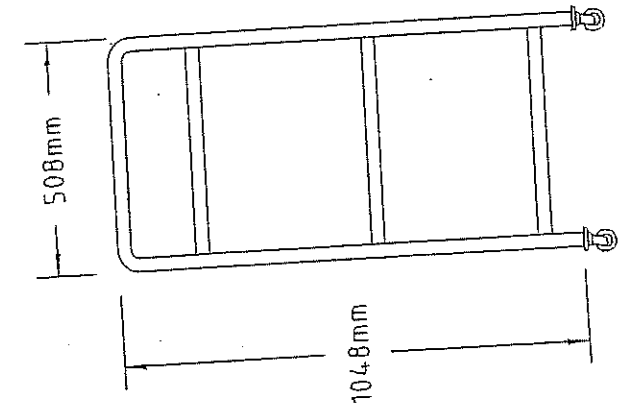

PANDANGAN SISI

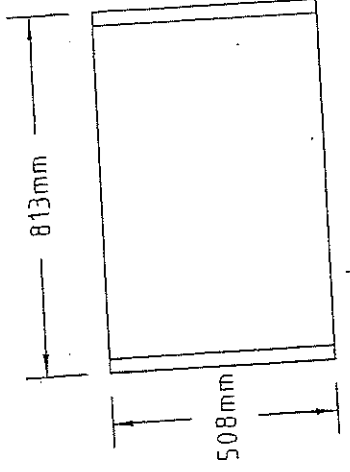

PANDANGAN ATAS

CATATAN:	SPESIFIKASI BAHAN		TARIKH	OLEH	SMK.
	SEMUA STRUKTUR DILAPISI "EPOXY"	KEPINGAN LOGAM 0.65/0.8/2.0MM			
UKURAN : W813 X D508 X H1048mm					1
					2
					3
					4
					5
TAJUK: BOOK TROLLEY WITH FLATE SHELVES (BTF64)					
NO. LUKISAN:					
NO. FAIL:					
SKALA: BEBAS					
ANGGARAN +0.1 / -0.3					

BOOK TROLLEY WITH SLOPING SHELVES

BTF65

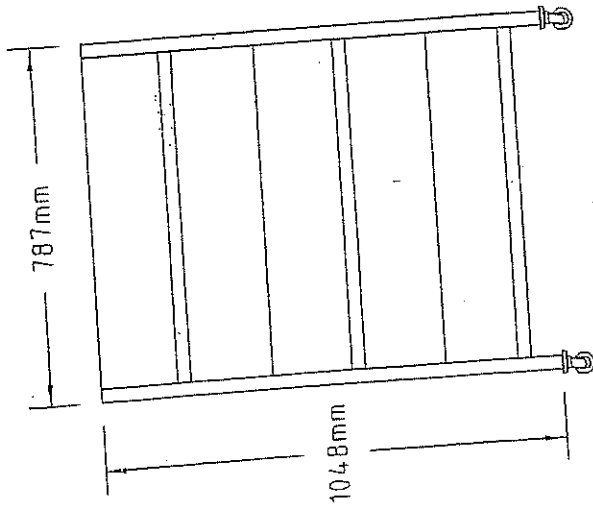

PANDANGAN DEPAN

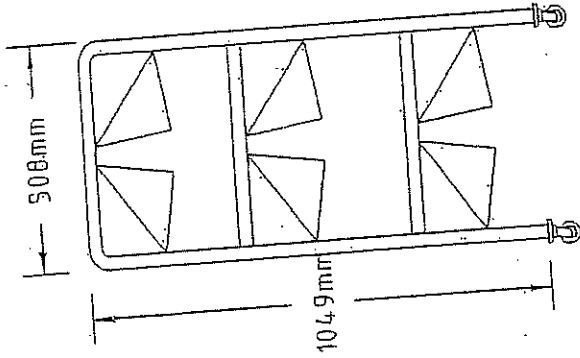

PANDANGAN SISI

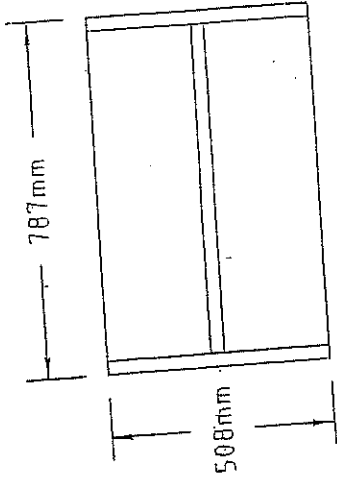

PANDANGAN ATAS

CATATAN:	SPESIFIKASI BAHAN		TARIKH	OLEH	SMK.
	KEPINGAN LOGAM 0.65/0.8/2.0MM				
SEMUA STRUKTUR DILAPISI EPOXY					1
					2
					3
					4
					5

TAJUK: BOOK TROLLEY WITH SLOPING SHELVES (BTF65)	
NO. LUKISAN:	
NO. FAIL:	
SKALA:	BEBAS

UKURAN : W181 X D508 X H1048mm	ANGGATAN +0.1 / -0.3
--------------------------------	----------------------

PROJECTOR TROLLEY PT67

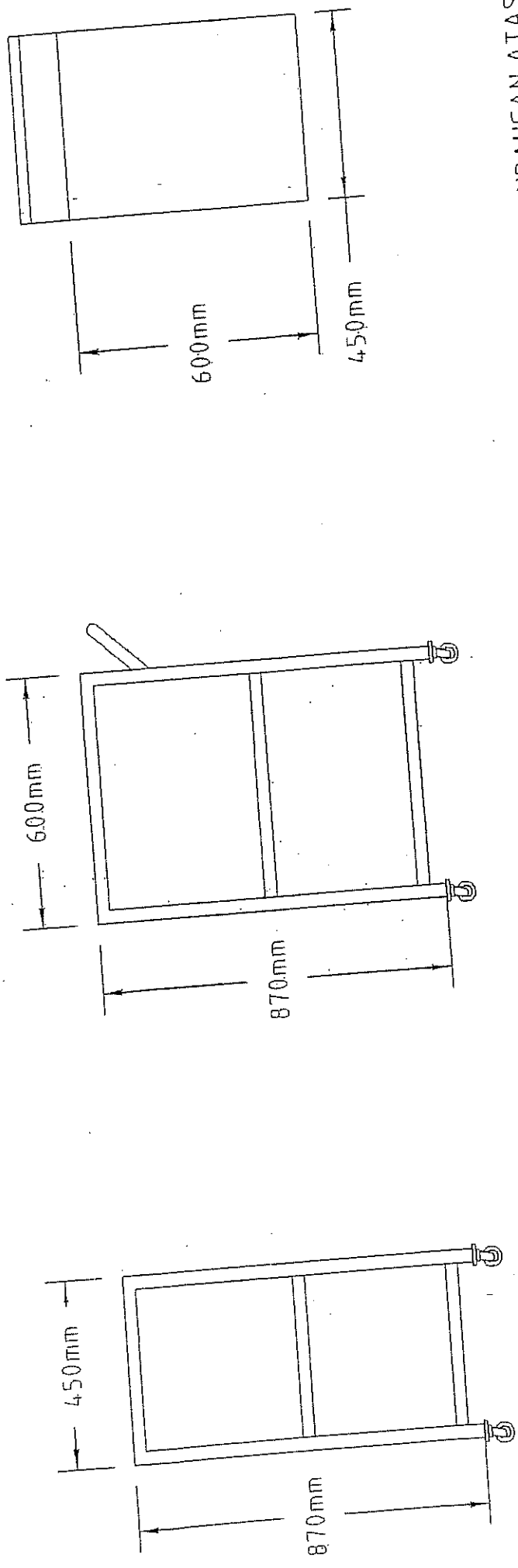

PANDANGAN SISI

PANDANGAN DEPAN

PANDANGAN ATAS

CATATAN:	SPESIFIKASI BAHAN		TARIKH	OLEH	SMK.
	Kepingan Logam 0.65/0.8/2.0mm				
SEMUA STRUKTUR DILAPISI "EPOXY"					1
					2
					3
					4
					5
TAJUK: PROJECTOR TROLLEY (P167)					
NO. LUKISAN:					
NO. FAIL:					
SKALA: BEBAS					
ANGgaran +0.1 / -0.3					
UKURAN : W450 X D600 X H870mm					

STUDY TABLE WITH LAMINATED TOP ST78

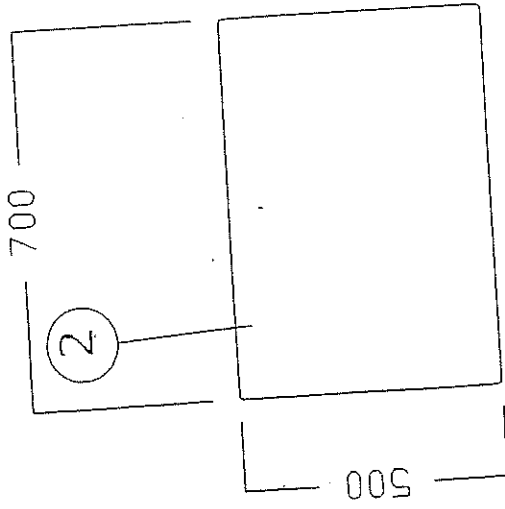

Pandangan Atas

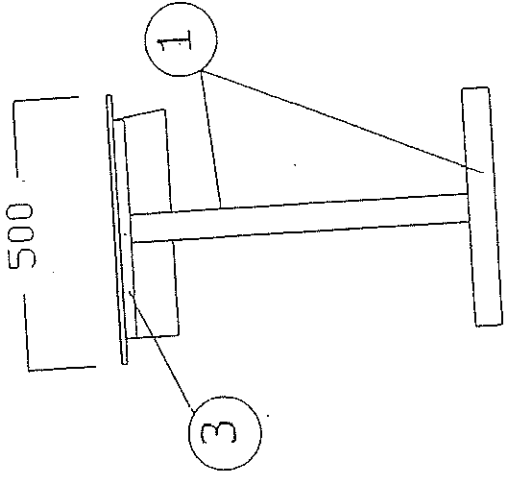

Pandangan Sisi

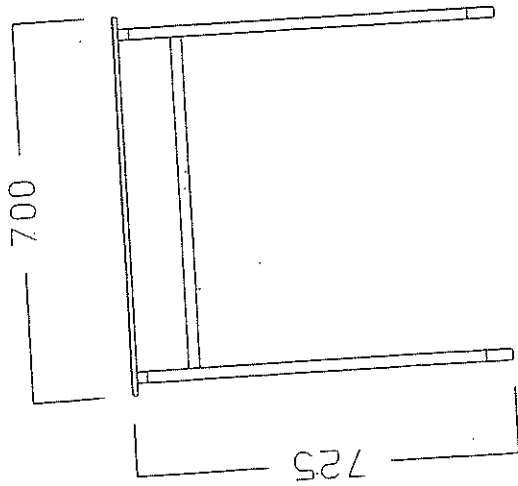

Pandangan Depan

CATATAN:	SPESIFIKASI BAHAN:		TARIKH	OLEH	SMK
	SEMUA STRUKTUR DILAPISI "EPOXY"	1-Rectangular Hollow Section 50 x 25 x 1,2mm 2-Laminated Top 500 x 700 x 15mm 3-Square Hollow Section 25 x 25 x 1mm			
					1
					2
					3
					4
					5

TAJUK :
STUDY TABLE WITH LAMINATED TOP

NO. LUKISAN :
NO. FAIL :

SKALA :

UKURAN W700 X D500 X H725

ANGGARAN 0.1/-0.3

STUDY CHAIR SC79

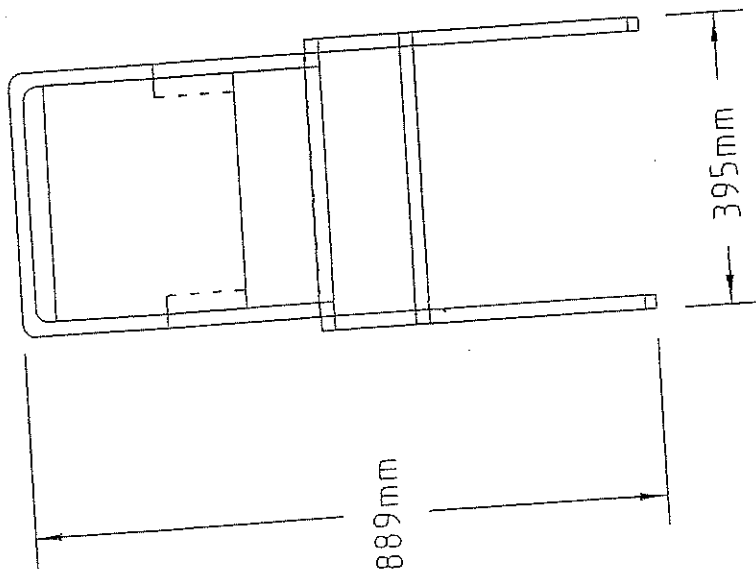

PANDANGAN HADAPAN

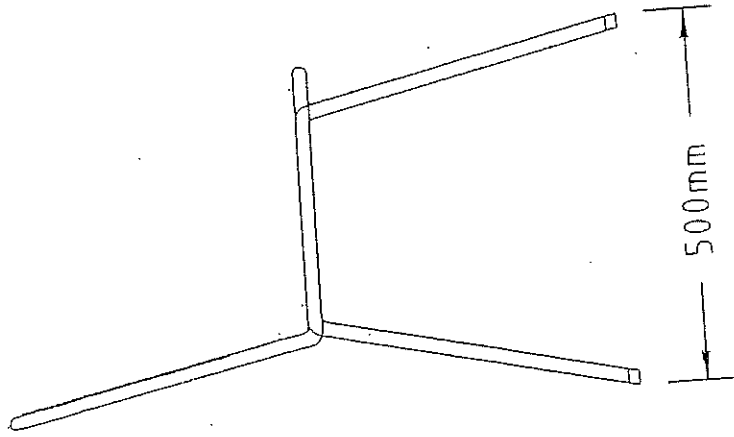

PANDANGAN SISI

CATATAN:	SPESIFIKASI BAHAN		TARIKH	OLEH	SMK.
	SEMUA STRUKTUR DILAPISI "EPOXY"	KEPINGAN LOGAM 0.65/0.8/2.0MM			
UKURAN : W385 X D465 X H889mm	TAJUK: STUDY CHAIR (SC79)				
	NO. LUKISAN:				
	NO. FAIL:				
	SKALA: BEBAS				
	ANGGARAN +0.1 / -0.3				

LABORATORY STOOL WITH CUSHION (HIGH)
LSC81

LAMPIRAN 44

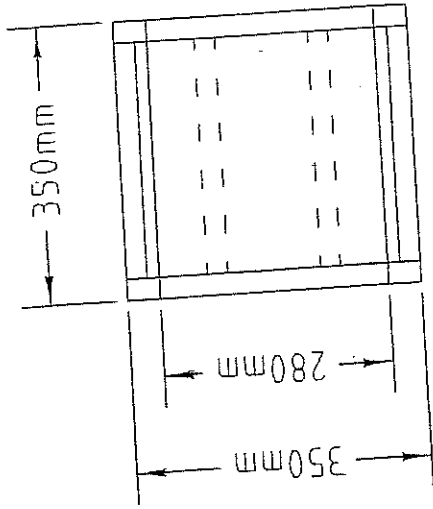
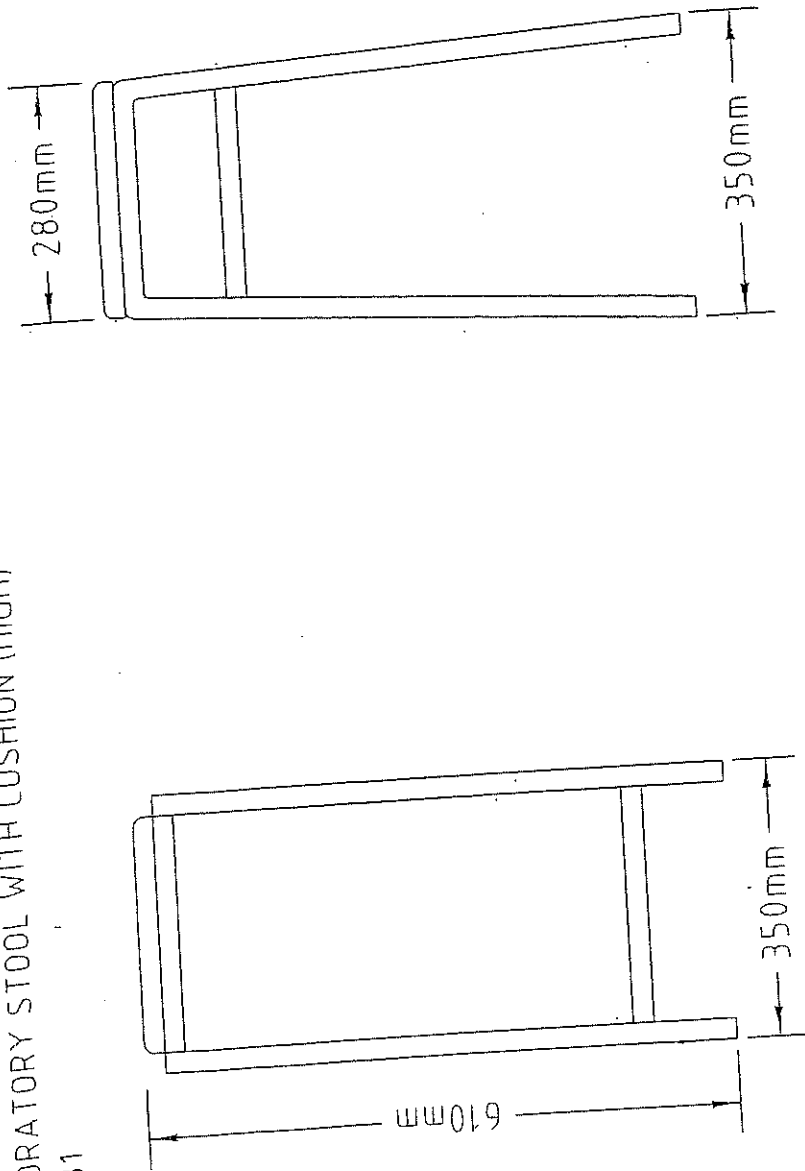

PANDANGAN ATAS

PANDANGAN SISI

PANDANGAN HADAPAN

CATATAN: SEMUA STRUKTUR DILAPISI "EPOXY"	SPESIFIKASI BAHAN		TARIKH	OLEH	SMK.	1	2	3	4	5	
	KEPINGAN LOGAM 0.65/0.8/2.0MM										
UKURAN : W350 X D350 X H610mm	ANGGARAN +0.1 / -0.3										
TAJUK: LABORATORY STOOL WITH CUSHION (HIGH) (LSC81)											
NO. LUKISAN:										SKALA: BEBAS	
NO. FAIL:											

SCHOOL BENCH
SB886

LAMPIRAN 45

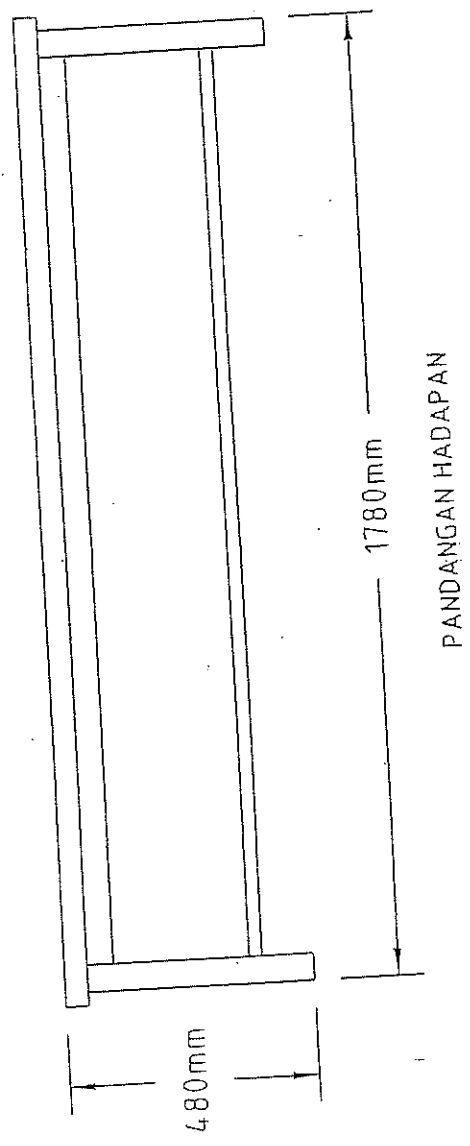
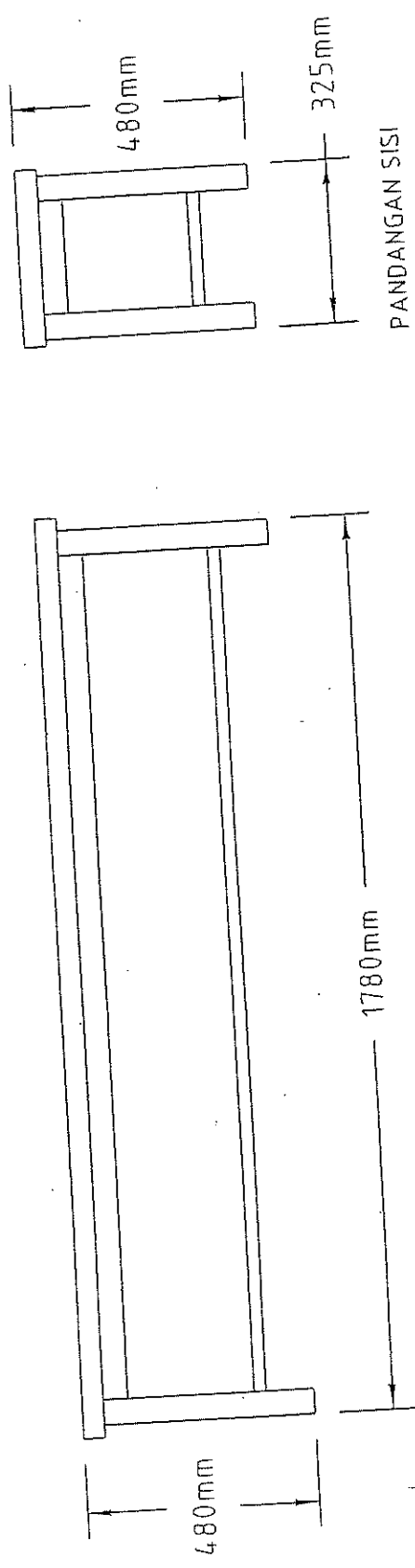
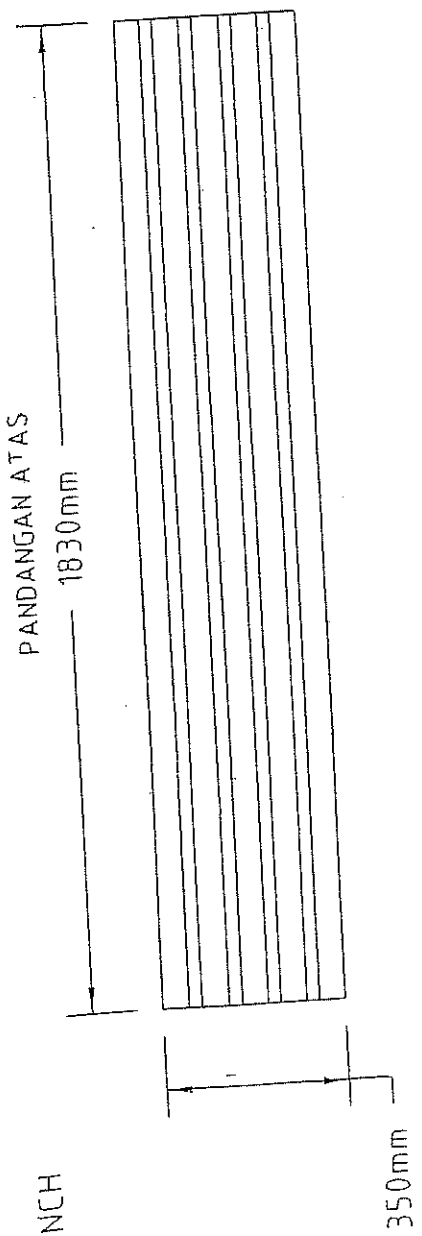

CATATAN:	SPESIFIKASI BAHAN	TARIKH	OLEH	SMK.	TAJUK:		NO. LUKISAN:	NO. FAIL:
					SCHOOL BENCH (SB886)			
SEMUA STRUKTUR DILAPISI "EPOXY"	KEPINGAN LOGAM 0.65/0.8/2.0MM			1				
				2				
				3				
				4				
				5				
UKURAN : W1830 X D350 X H480mm	ANGGARAN +0.1 / -0.3							
								SKALA: B'BAS

SCHOOL DINING / LIBRARY TABLE SDLT87

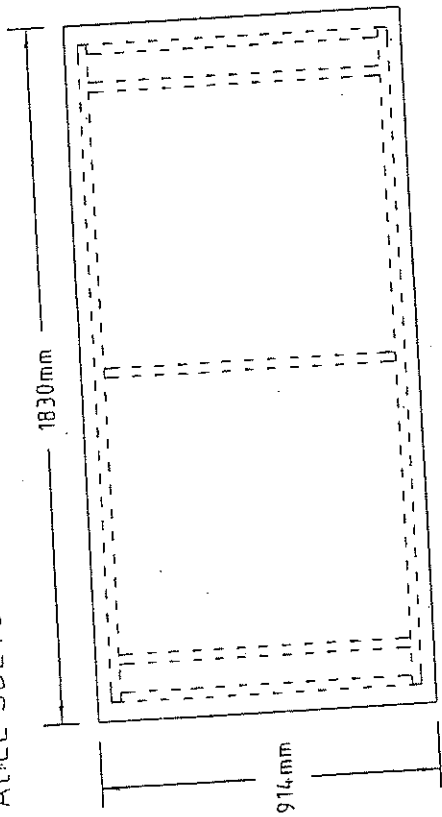

PANDANGAN ATAS

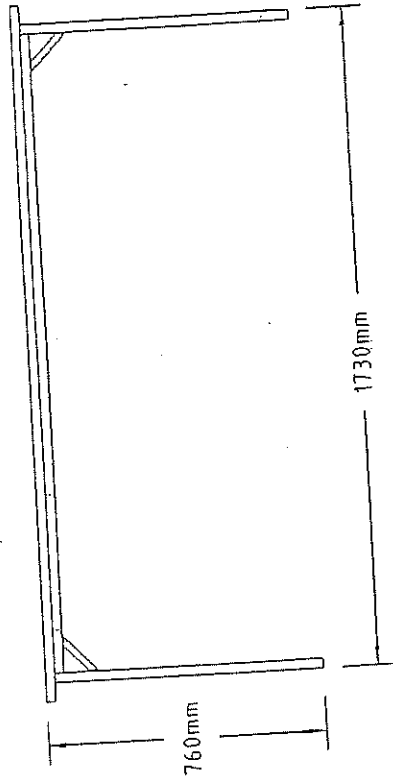

PANDANGAN HADAPAN

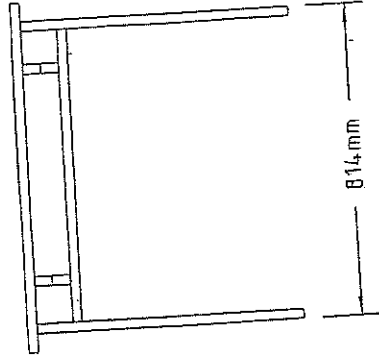

PANDANGAN SISI

CATATAN:	SPESIFIKASI BAHAN		TARIKH	OLEH	SMK.
	1	2			
SEMUA STRUKTUR DILAPISI "EPOXY"	KEPINGAN LOGAM 0.65/0.8/2.0MM				1
					2
					3
					4
					5
TAJUK: SCHOOL DINING / LIBRARY TABLE (SDLT87)					
NO. LUKISAN:					
NO. FAIL:					
SKALA: BEBAS					
UKURAN : W1830 X D914 X H760mm					
ANGGARAN +0.1 / -0.3					

TUTORIAL CHAIR WITH TABLE
TCT91

LAMPIRAN 47

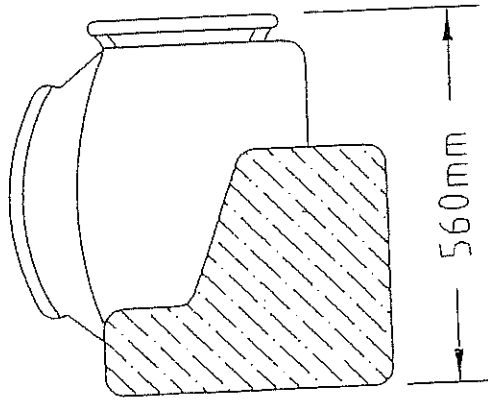

PANDANGAN ATAS

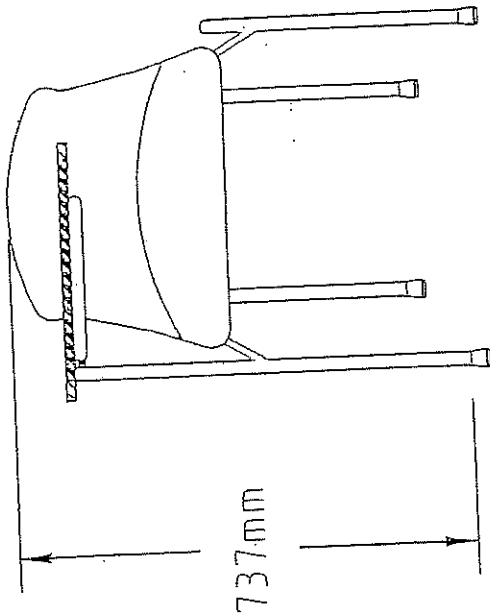

PANDANGAN HADAPAN

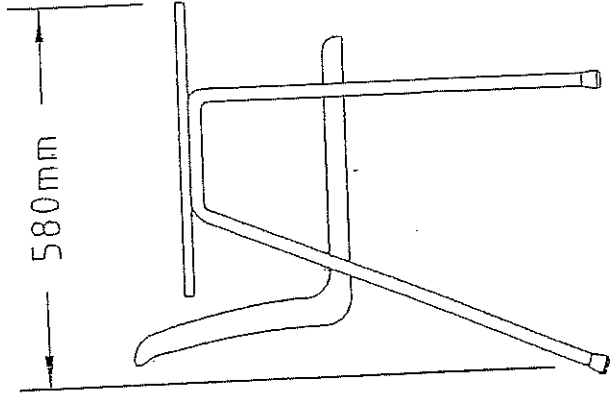

PANDANGAN SISI

CATATAN:	SPESIFIKASI BAHAN		TARIKH	OLEH	SMK.
	KEPINGAN LOGAM 0.65/0.8/2.0MM				
SEMUA STRUKTUR DILAPISI "EPOXY"					1
					2
					3
					4
					5
TAJUK: TUTORIAL CHAIR WITH TABLE (T91)					
NO. LUKISAN:					
NO. FAIL:					
SKALA: BEBAS					
ANGGARAN +0.1 / -0.3					
UKURAN : W560 X D580 X H737mm					

STUDENT CHAIR
SCR92

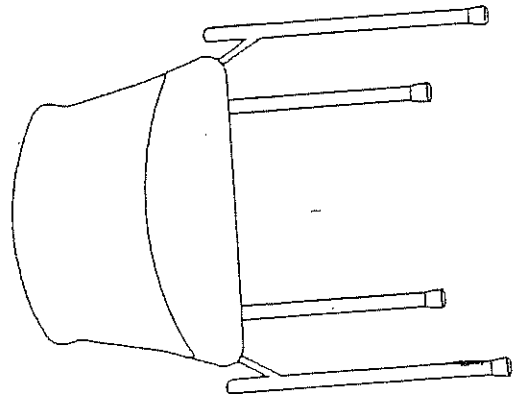

PANDANGAN HADAPAN

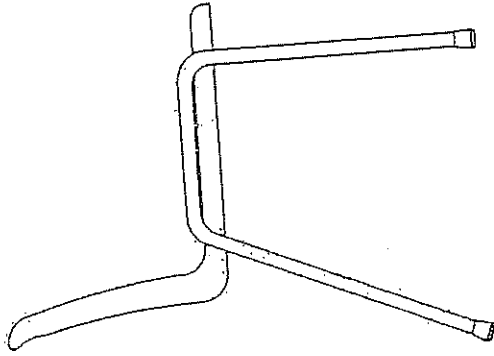

PANDANGAN SISI

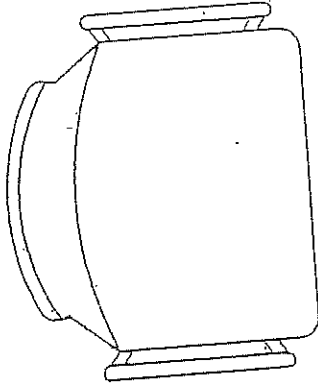

PANDANGAN ATAS

CATATAN:	SPESIFIKASI BAHAN	TARIKH	OLEH	SMK	TAJUK: STUDENT CHAIR (SCR92)	SKALA:	
						NO. LUKISAN:	BEBAS
SERUA STRUKTUR DILAPISI "EPOXY"	KEPINGAN LOGAM 0.65/0.0/2.0MM			1			
				2			
				3			
				4			
				5			
	ANGGARAN +0.1 / -0.3						
	SEAT : POLYPROPYLENE SHELL LEG, RACE : MILD STEEL ROUND TUBE						

STUDENT SINGLE BED C/W WIRE MESH

SSB97

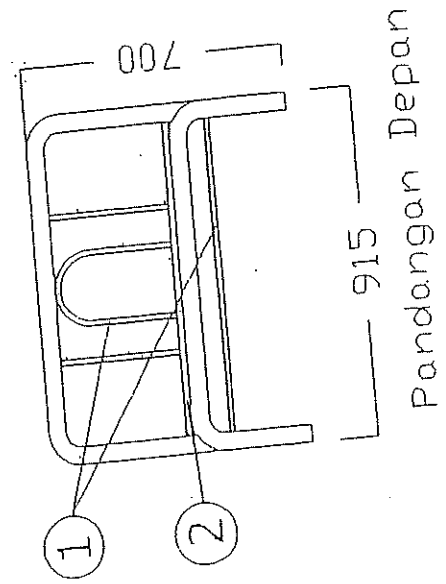
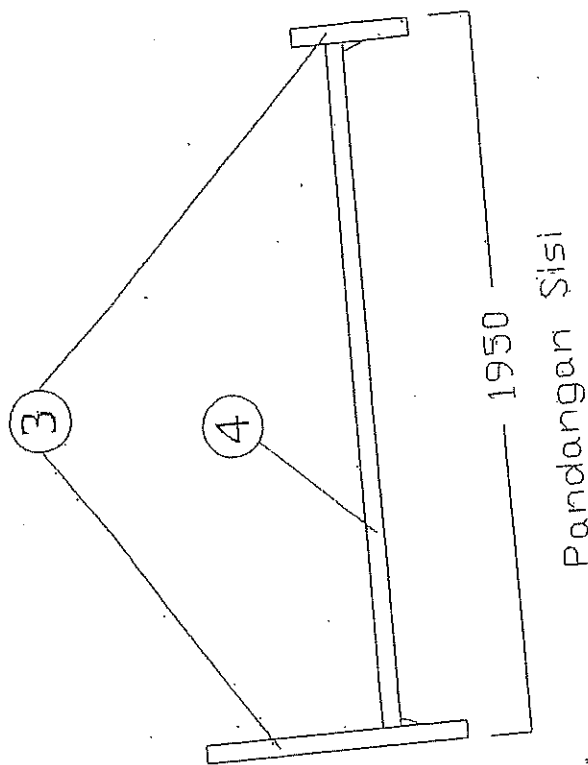
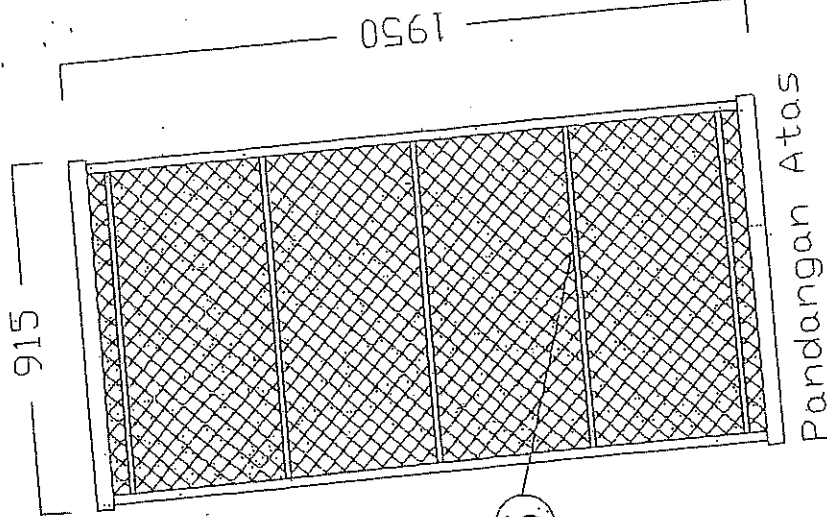

CATATAN:	SPESIFIKASI BAHAN:		TARIKH	OLEH	SMK
	1- Round tiub 16 diameter	2- Round tiub 19 diameter			
SEMUA STRUKTUR DILAPISI "EPOXY"	2- Round tiub 32 diameter	3- Rectangular Hollow Section 32 x 25mm			1
	4- Rectangular Hollow Section 16 x 16mm	5- Square Hollow Section 16 x 16mm			2
					3
					4
					5
TAJUK : STUDENT SINGLE BED C/W WIRE MESH					
NO. LUKISAN :					
NO. FAIL :					
SKALA :					
ANGGERAN D.1/-0.3					
UKURAN W915 X D1950 X H700 X 32M4					

SINGLE BED c/w PLYWOOD BASE SB98

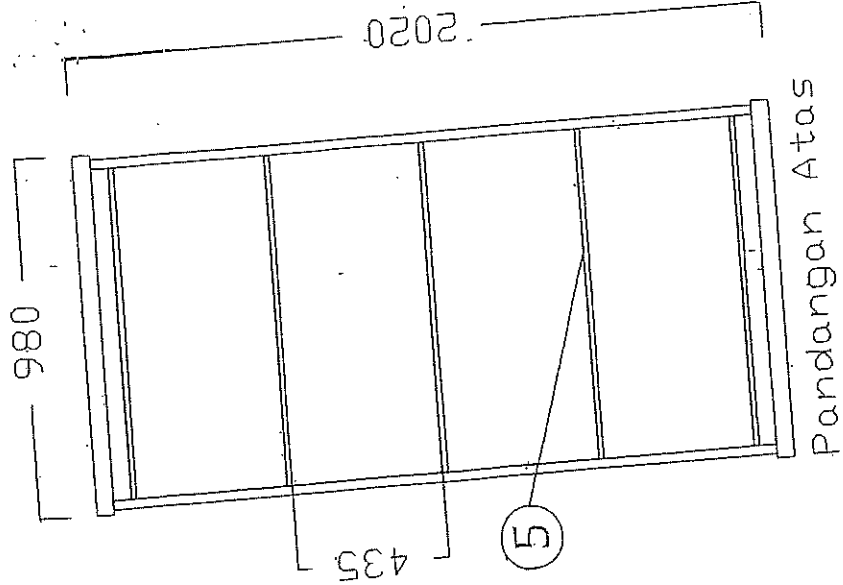
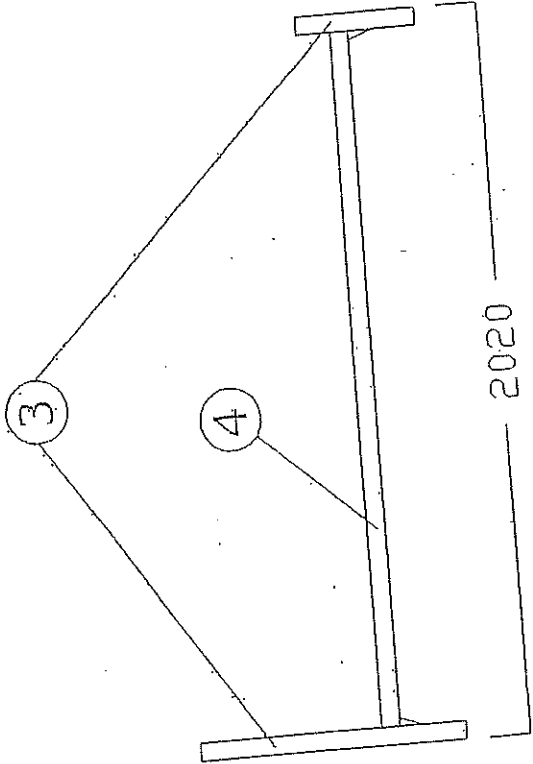
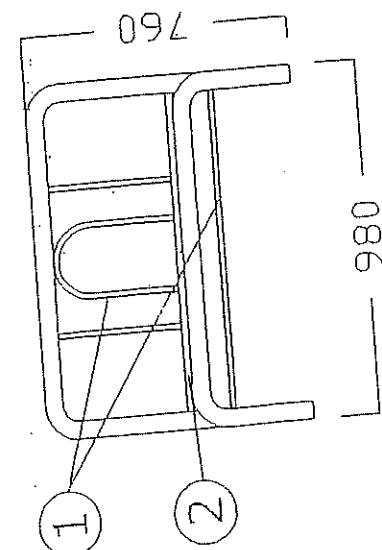

DATARAN	SPESIFIKASI BAHAN	TARIKH	OLEH	SMK	TAJUK :	
					NO. LUKISAN :	SKALA :
SEMUA STRUKTUR DILAPISI "EPOXY"	1- Round tiub 16 diameter			1		SINGLE BED c/w PLYWOOD BASE
	2- Round tiub 19 Diameter			2		
	3- Round tiub 50 Diameter			3		
	4- Rectangular Hollow Section 50 x 25mm			4		
	5- Square Hollow Section 16 X 16mm			5		
UKURAN 1980 X 2020 X H760 X 50MM	ANGGARAN 0.1/-0.3					

STUDENT DOUBLE DECKER BED C/W WIRE MESH
SDD102

LAMPIRAN 53

915

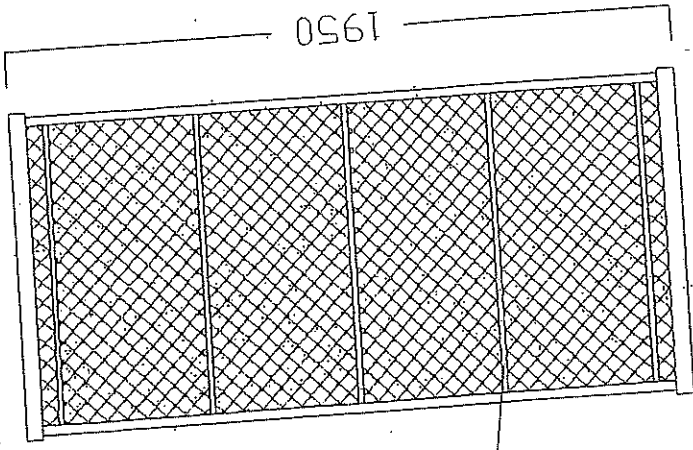

Pandangan Atas

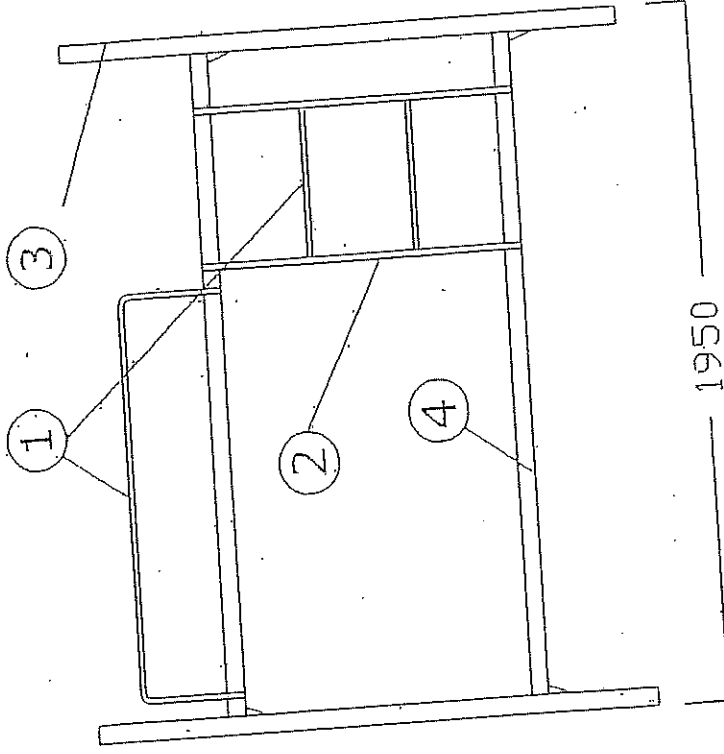

1950

Pandangan Sisi

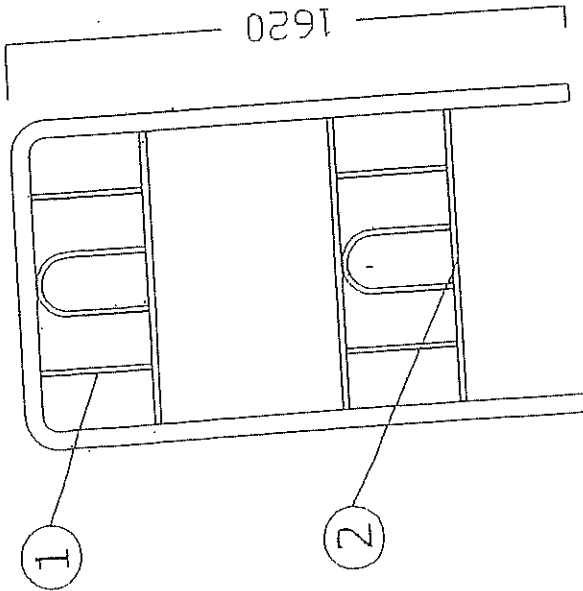

915

Pandangan Depan

CATATAN:	TARIKH	DLEH	SMK	SPESIFIKASI BAHAN:	
				1	2
SEMUA STRUKTUR DILAPISI "EPOXY"			1	2	1-Round tiub 16 diameter 2-Round tiub 19 Diameter 3-Round tiub 32 Diameter 4-Rectangular Hollow Section 32 x 25mm 5-Square Hollow Section 16 X 16mm
UKURAN W915 X D1950 X H1620 X 32MM			3	4	ANGGARAN 0.1/-0.3
			5		

TAJUK :

STUDENT DOUBLE DECKER BED C/W WIRE MESH

SKALA :

NO. LUKISAN :

NO. FAIL :

DOUBLE DECKER BED C/W PLYWOOD BASE

DD103

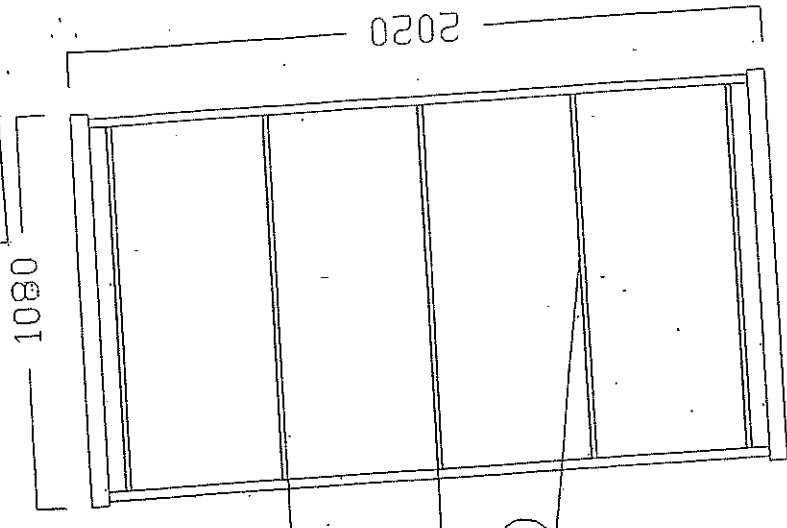

Pandangan Atas

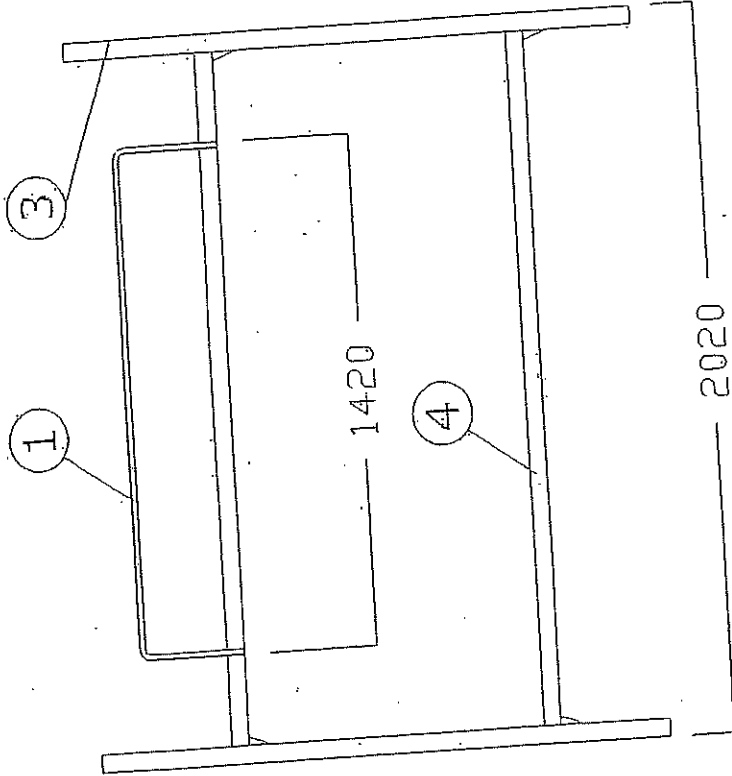

Pandangan Sisi

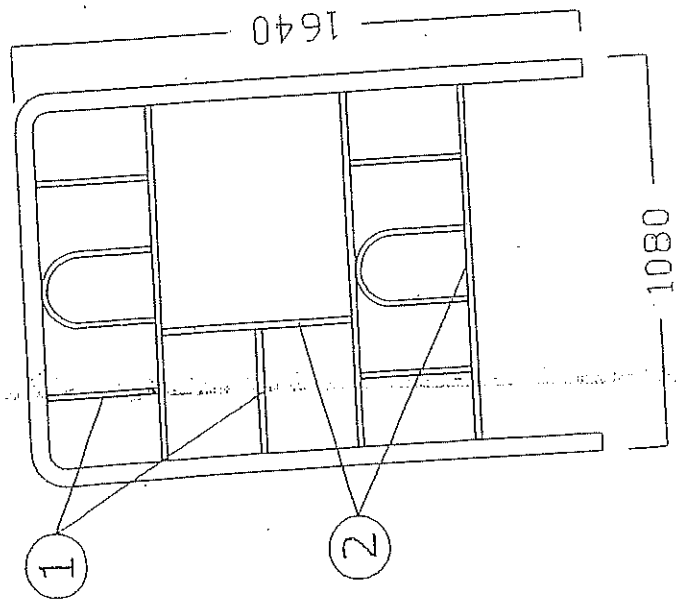

Pandangan Depan

TARIKH	DLEH	SMK	TAKJUK	
			NO. LUKISAN	NO. FAIL
		1		
		2		
		3		
		4		
		5		

DATATAN: SEMUA STRUKTUR DILAPISI 'EPOXY'	SPESIFIKASI BAHAN: 1-Round tiub 16 diameter 2-Round tiub 19 Diameter 3-Round tiub 50 Diameter 4-Rectangular Hollow Section 16 X 16mm 5-Square Hollow Section 16 X 16mm
	UKURAN V1080 X D2020 X H1640 X 50MM ANGGARAN D.I. -0.3

DOUBLE DECKER BED C/W PLYWOOD BASE

NO. LUKISAN :

NO. FAIL :

SKALA :