

LAMPIRAN A

4 DRAWER FILING CABINET
4DF3

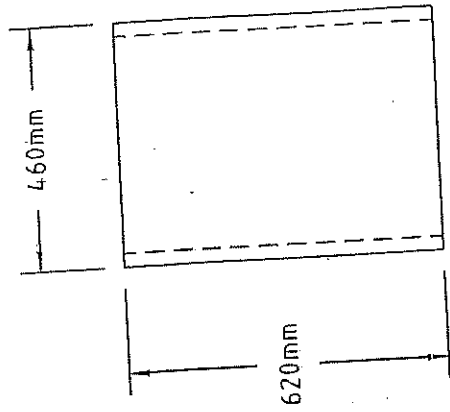
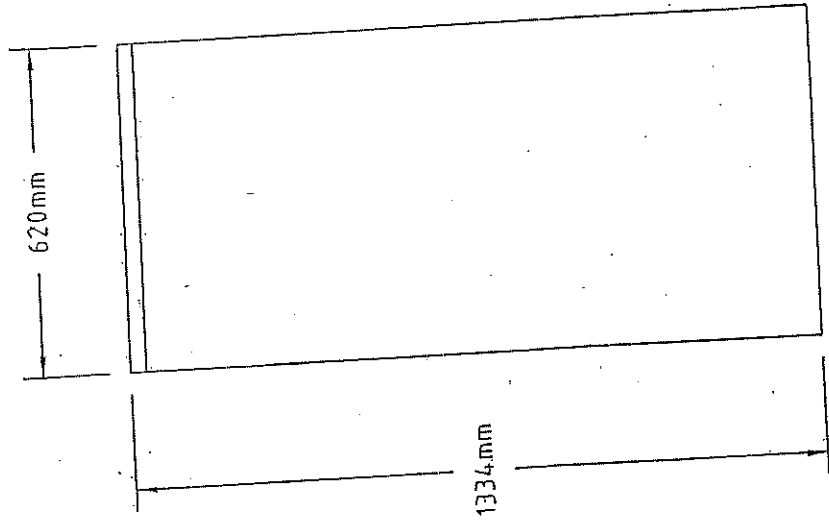
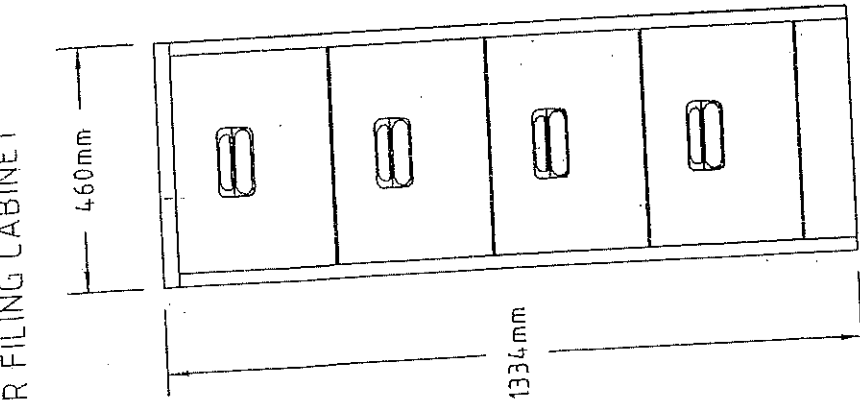

LAMPIRAN 1

PANDANGAN HADAPAN

PANDANGAN SISI

PANDANGAN ATAS

CATATAN: SEMUA STRUKTUR DILAPISI "EPOXY"	SPESIFIKASI BAHAN		TARIKH	OLEH	SMK.
	KEPINGAN LOGAM 0.65/0.8/2.0MM				1
UKURAN: W460 X D620 X H1334mm	ANGGARAN +0.1 / -0.3				2
					3
					4
					5
TAJUK: & DRAWER FILING CABINET (4DF3)					
NO. LUKISAN:					
NO. FAIL:					
SKALA: BEBAS					

3 DRAWER FILING CABINET
3DF2

LAMPIRAN 2

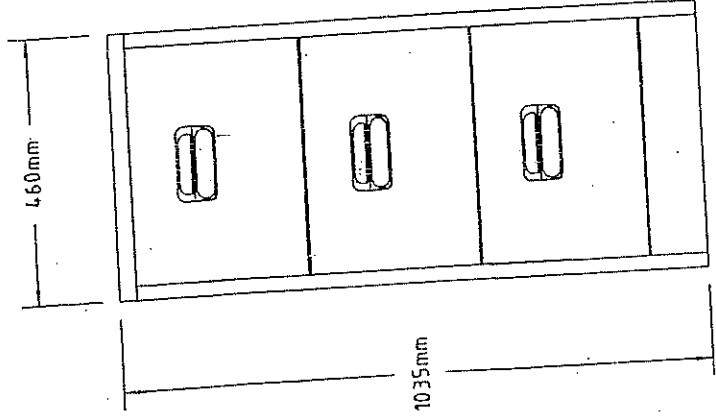

PANDANGAN DEPAN

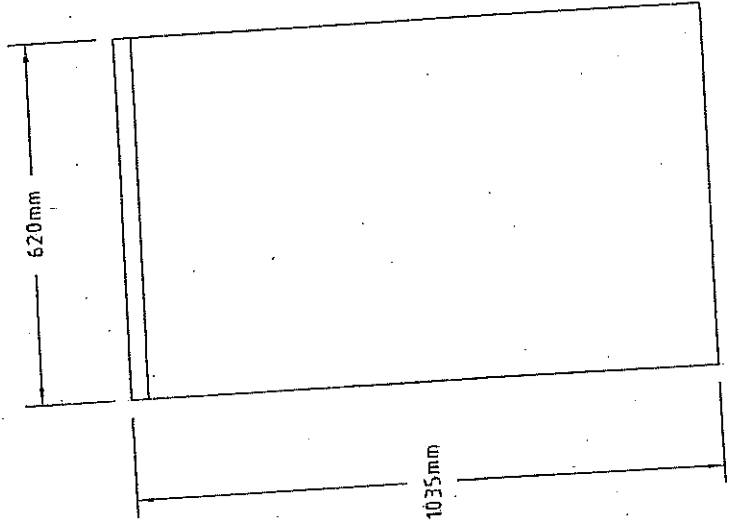

PANDANGAN SISI

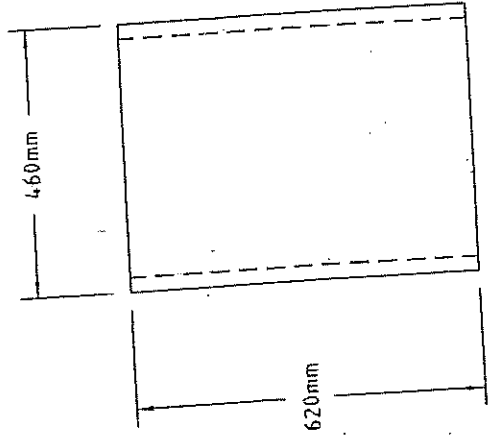

PANDANGAN ATAS

CATATAN:	SPESIFIKASI BAHAN		TARIKH	OLEH	SMK.
	1	2			
SEMUA STRUKTUR DILAPISI "EPOXY"	KEPINDAN LOGAM 0.65/0.8/2.0MM				1
					2
					3
					4
					5
TAJUK: 3 DRAWER FILING CABINET (3DF2)					
NO. LUKISAN:					
NO. FAIL:					
SKALA: BEBAS					
UKURAN: W460 X D620 X H1035mm					
ANGGARAN: N +0.1 / -0.3					

4 DRAWER CARD INDEX
4DC10

LAMPIRAN 3

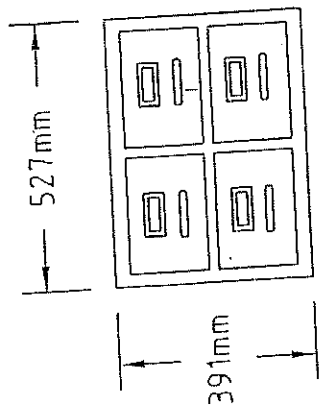

PANDANGAN DEPAN

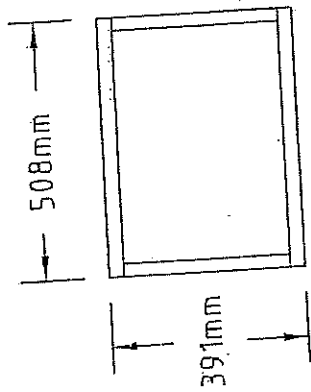

PANDANGAN SISI

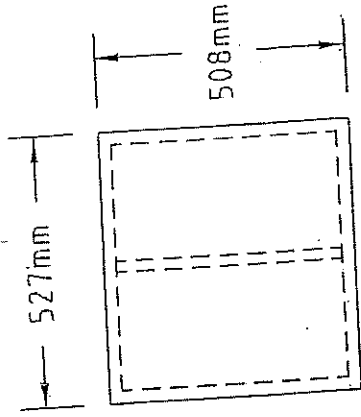

PANDANGAN ATAS

CATATAN:	SPESIFIKASI BAHAN		TARIKH	OLEH	SMK.
	SEMUA STRUKTUR DILAPISI "EPOXY"	KEPINGAN LOGAM 0.65/0.8/2.0MM			
UKURAN: 41527 X 0508 X H391mm					1
					2
					3
					4
					5
TAJUK: 4. DRAWER CARD INDEX (4DC10)					
NO. LUKISAN:					
NO. FAIL:					
SKALA: BEBAS					
ANGGARAN +0.1 / -0.3					

PIGEON HOLE CABINET C/W 18 PIGEON HOLES

LAMPIRAN 4

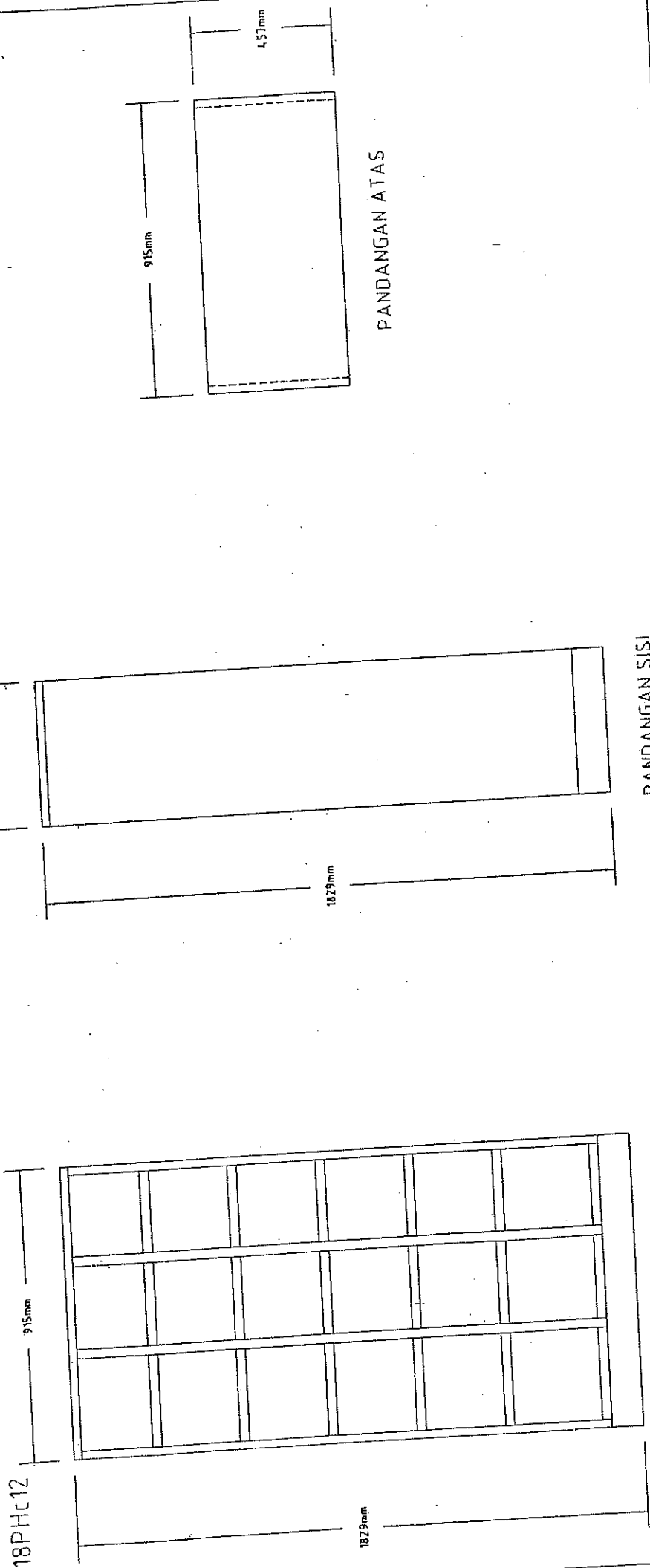

PANDANGAN DEPAN		PANDANGAN SISI	
CATATAN:	SPEKIFIKASI BAHAN	TARIKH	OLEH
SEHUA STRUKTUR DILAPISI "EPOXY"	KEPINGAN LOGAM 0.65/O.B/2.0MM		SMK. 1
			2
			3
			4
			5
UKURAN: W915 X D457 X H1829mm		~NGGARAN +0.1 / -0.3	

TAJUK:
PIGEON HOLE CABINET c/w 18 PIGEON HOLES (18PHCTZ)

NO. LUKISAN:
NO. FAIL:

SKALA:
BEBAS

PIGEON HOLES CABINET C/W 15 PIGEON HOLES
15PHc13

LAMPIRAN 5

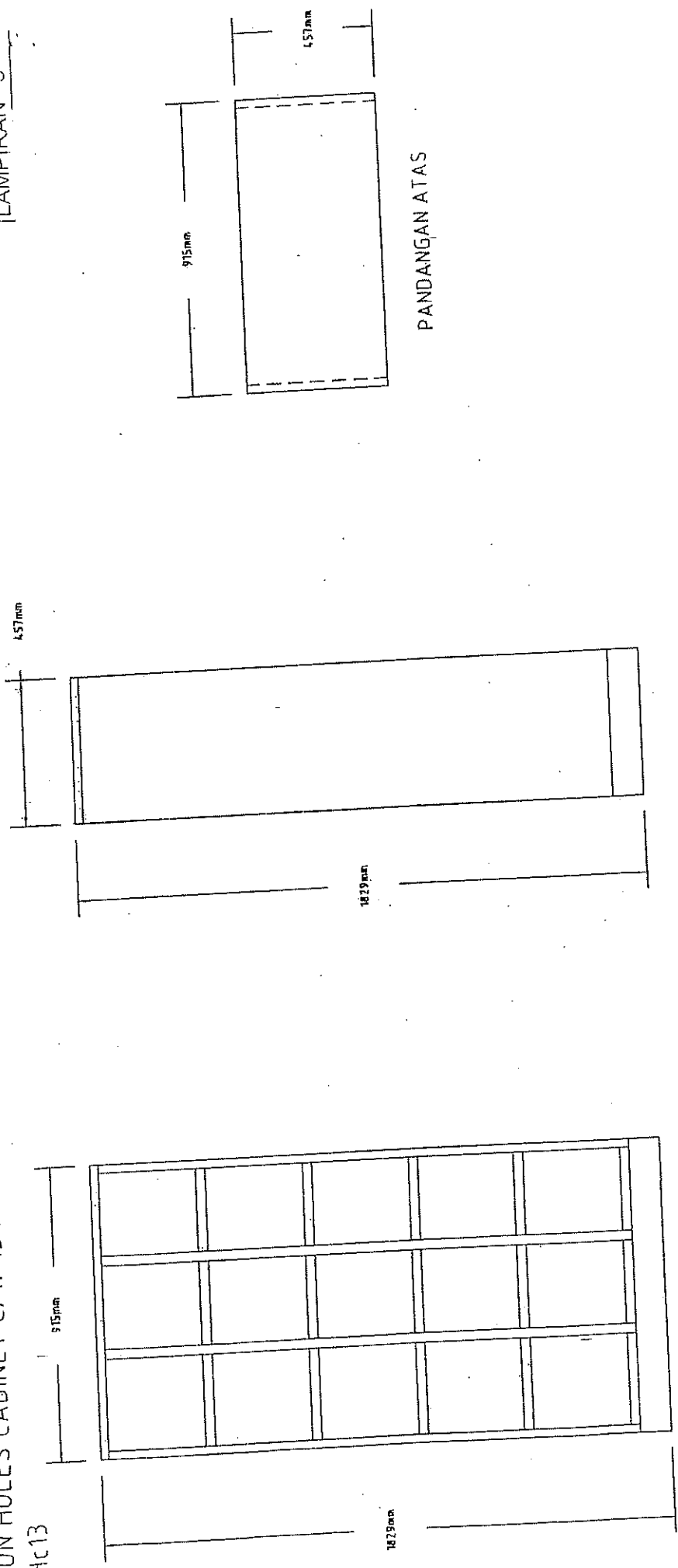

PANDANGAN ATAS

PANDANGAN SISI

PANDANGAN DEPAN

CATATAN:	SPESIFIKASI BAHAN		TARIKH	OLEH	SMK.
	SEMUA STRUKTUR DILAPISI "EPOXY"	KEPINGAN LOGAM 0.65/0.8/2.0MM			
UKURAN: W915 X D457 X H1829mm					1
					2
					3
					4
					5

TAJUK:
PIGEON HOLE CABINET C/W 15 PIGEON HOLES (15PHc13)

NO. LUKISAN:
SKALA:
I.O. FAIL:
BEBAS

ANGGARAN +0.1 / -0.3

MANUAL MOBILE COMPACTUS - 4 BAYS
4MBC14

LAMPIRAN 6

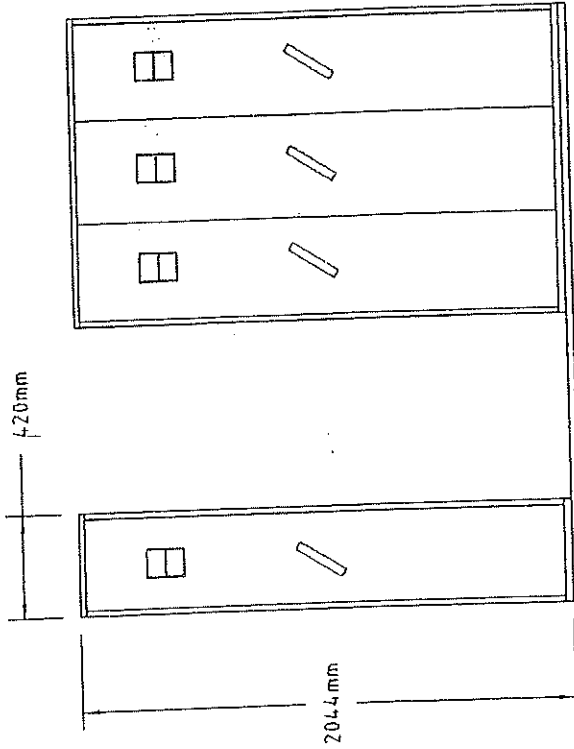
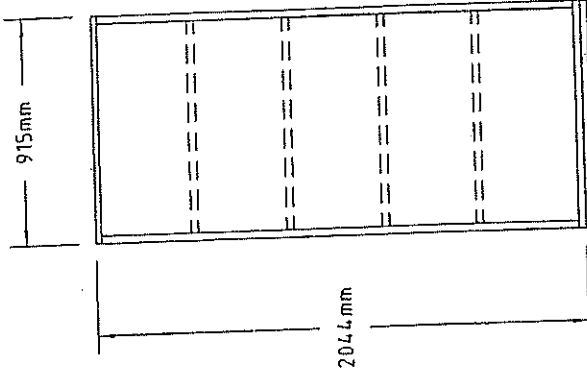
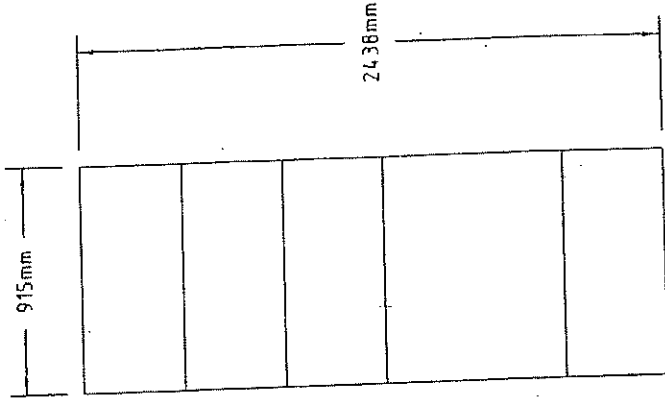

PANDANGAN ATAS

PANDANGAN TEPI

PANDANGAN DEPAN

CATATAN:	SPESIFIKASI BAHAN		TARIKH	OLEH	SMK.
	KEPINGAN LOGAM 0.85/0.8/7.0MM				
SEMUA STRUKTUR DILAPISI "EPOXY"					1
					2
					3
					4
					5
OVERALL SIZE : W915 X L2436mm SIZE PER BAY : W420 X D419mm WALKING AREA : W762mm					
TAJUK: 1 MANUAL MOBILE COMPACTUS - 4 BAYS (4MBC14)					
NO. LUKISAN:					
NO. FAIL:					
SKALA: BEBAS					

MANUAL MOBILIF COMPACTUS - 6 BAYS 6BMC15

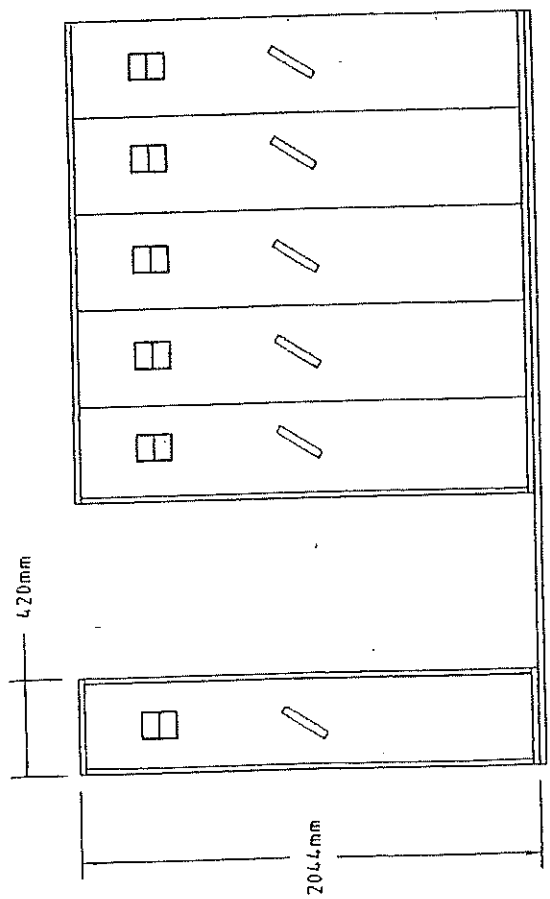
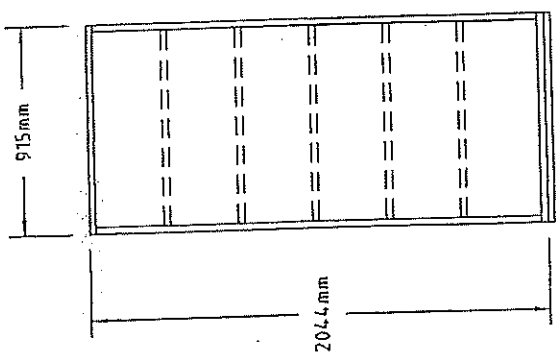
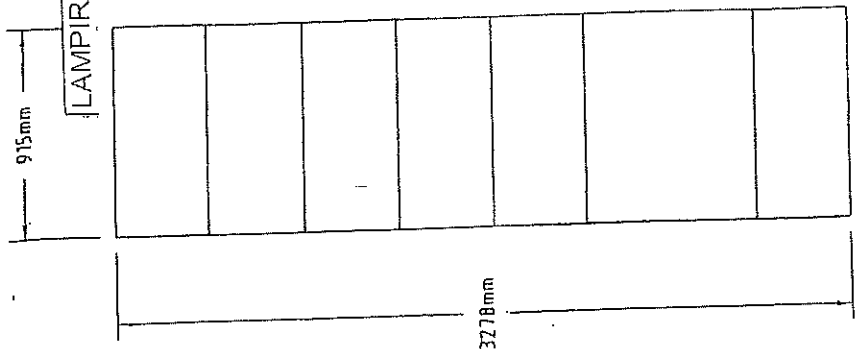

PANDANGAN ATAS

PANDANGAN TEPI

PANDANGAN DEPAN

CATATAN:	SPESIFIKASI BAHAN		TARIKH	OLEH	SMK.
	KEPINGAN LOGAM 0.65/0.8/2.0MM				
SEMUA STRUKTUR DILAPISI "EPOXY"					1
					2
					3
					4
					5
TAJUK: MANUAL MOBILIF COMPACTUS - 6 BAYS (6BMC15)					
NO. LUKISAN:					
NO. FAIL:					
SKALA: BEBAS					
OVERAL SIZE: W915 X L2438mm SIZE PER BAY: W915 X D419mm WALKING AREA: W762mm					
ANGGARAN -0.1 / -0.3					

FULL HEIGHT OPEN DOOR CUPBOARD c/w 3 SHELVES

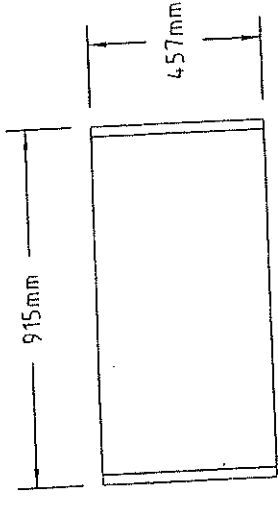
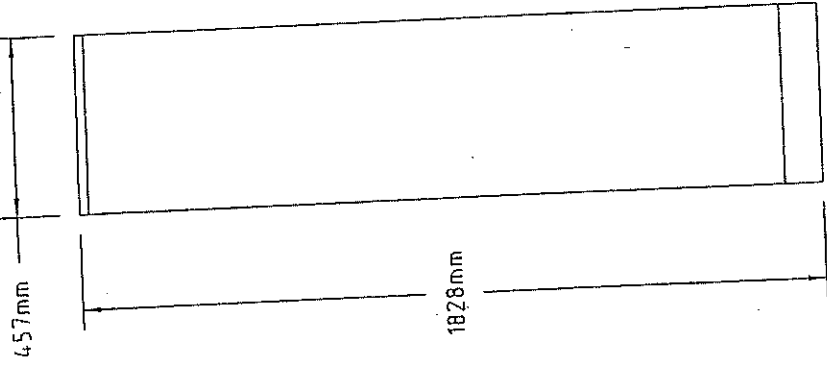
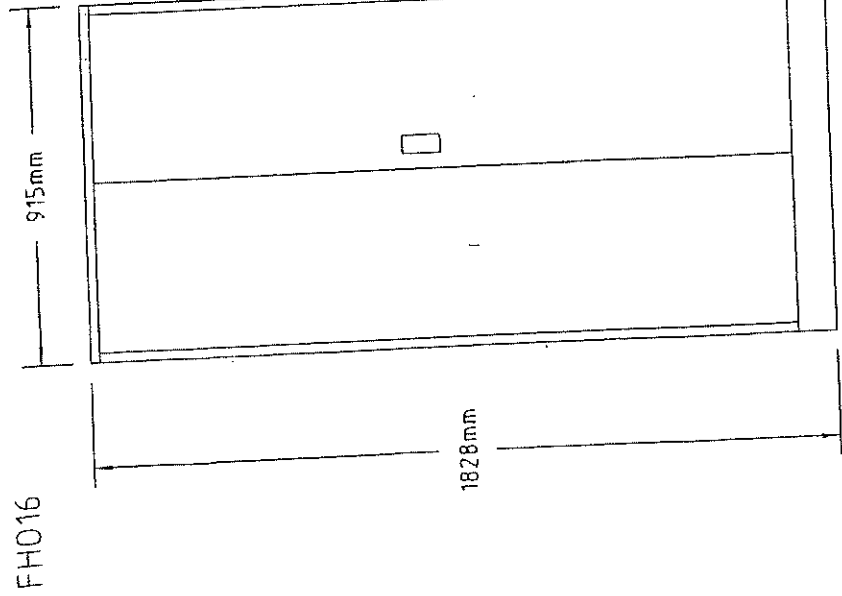

PANDANGAN ATAS

PANDANGAN SISI

PANDANGAN DEPAN

CATATAN:	SPESIFIKASI BAHAN	TARIKH	OLEH	SMK	PANDANGAN SISI		
					NO. LUKISAN:	SKALA:	
SEMUA STRUKTUR DILAPISI "EPOXY"	KEPINGAN LOGAM 0.65/0.8/2.0MM			1		TAJUK: FULL HEIGHT OPEN DOOR CUPBOARD c/w 3 SHELVE (FH016)	
				2			
				3			
				4			
				5			
UKURAN : W915 X D457 X H1828mm	ANGGAPAN +0.1 / -0.3					NO. FAIL:	BEBAS

FULL HEIGHT SLIDING DOOR CUPBOARD c/w 3 SHELVES
FHS17

LAMPIRAN 9

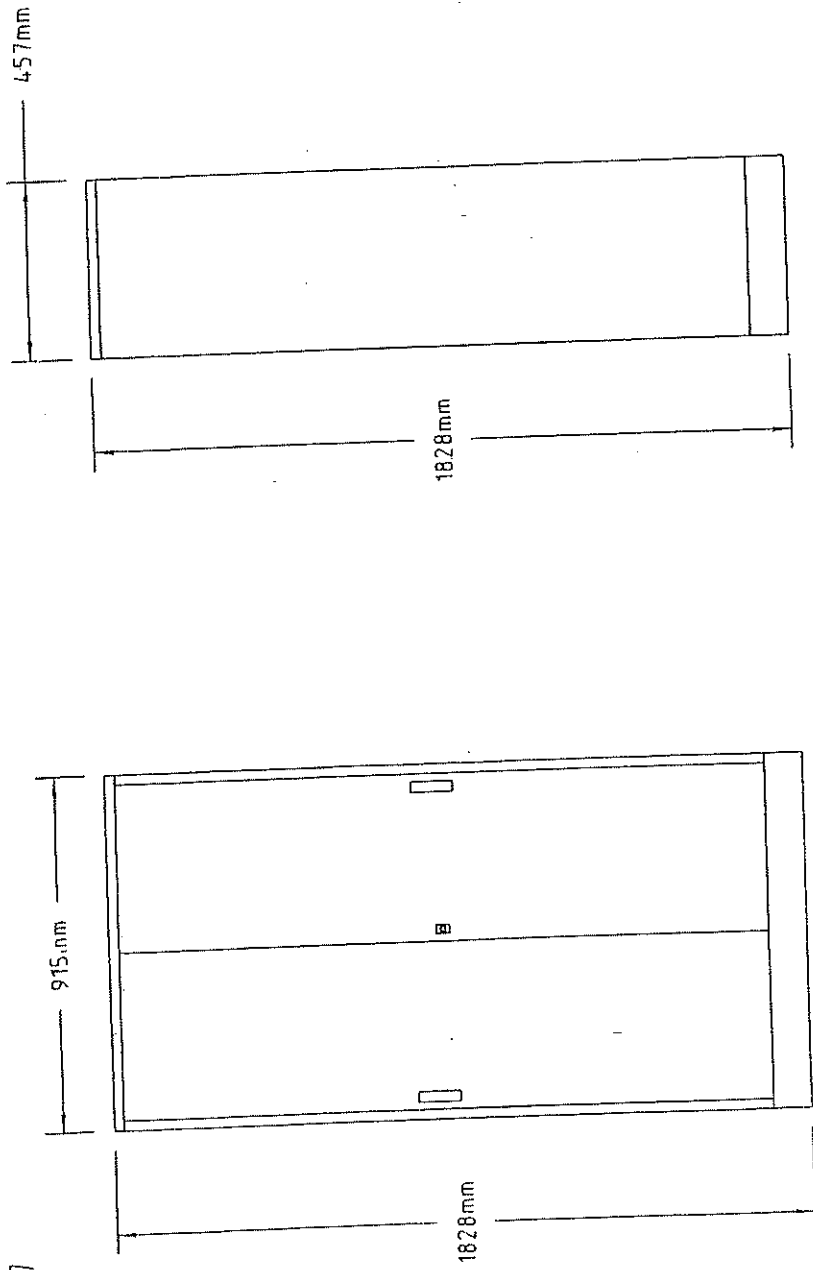

PANDANGAN ATAS

PANDANGAN SISI

PANDANGAN DEPAN

CATATAN:	SPESIFIKASI BAHAN		TARIKH	OLEH	SMK.
	KEPINGAN LOGAM 0.65/0.8/2.0MM				
SEMUA STRUKTUR DILAPISI "EPOXY"					1
					2
					3
					4
					5
UKURAN: W915 X D457 X H1828mm	ANGGARAN -0.1 / -0.3				

TAJUK:
FULL HEIGHT SLIDING DOOR CUPBOARD C/W 3 SHELVES (FHS17)

NO. LUKISAN:
SKALA:
NO. FAIL:
BEBAS

FULL HEIGHT SLIDING GLASS DOOR CUPBOARD c/w 3 SHELVES
FSG18

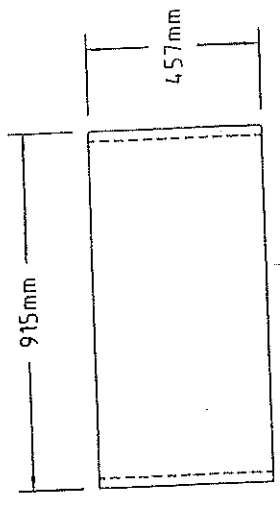
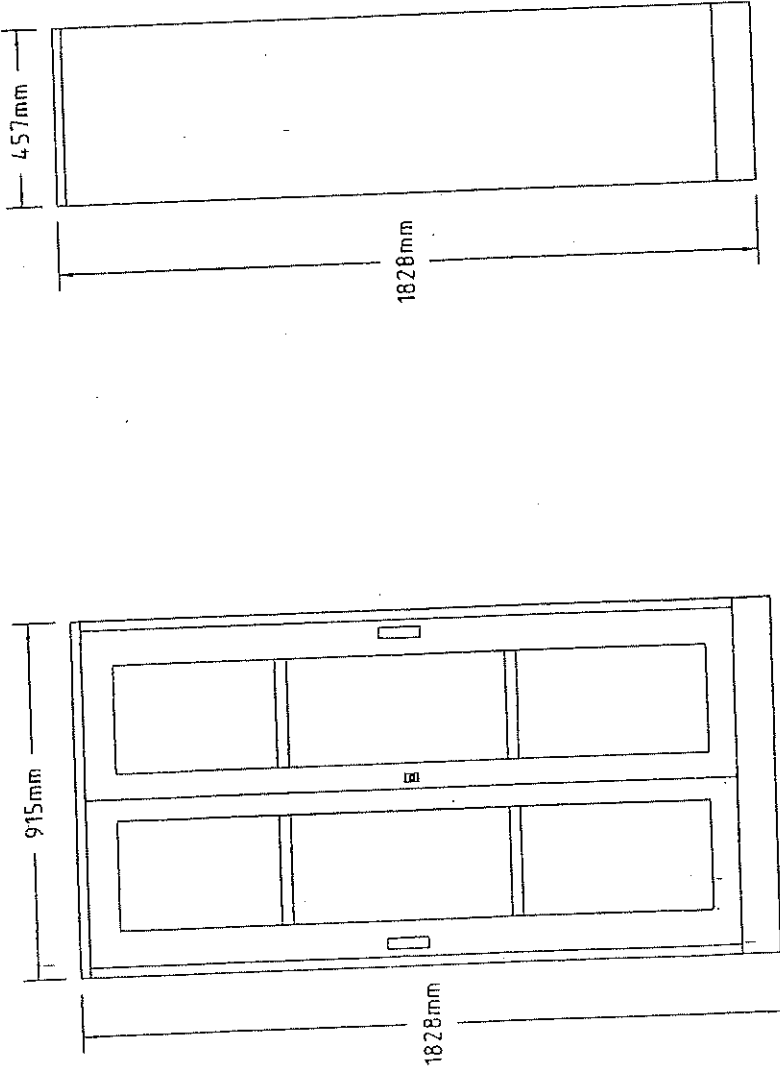

PANDANGAN ATAS

PANDANGAN SISI

PANDANGAN DEPAN

CATATAN:	SPESIFIKASI BAHAN		TARIKH	OLEH	SMK
	KEPINGAN LOGAM 0.55/0.8/2.0MM				1
SEHUA STRUKTUR DILAPISI "EPOXY"					2
					3
					4
					5
UKURAN: W915 X D457 X H1828mm	ANGGARAN +0.1 / -0.3				
TAJUK: FULL HEIGHT SLIDING GLASS DOOR CUPBOARD c/w 3 SHELVES (FSG18)					
NO. LUKISAN:					
SKALA: BEBAS					
NO. FAIL:					

LAMPIRAN 11

LATERAL FILING CUPBOARD WITH 5 SETS LATERAL SLF19

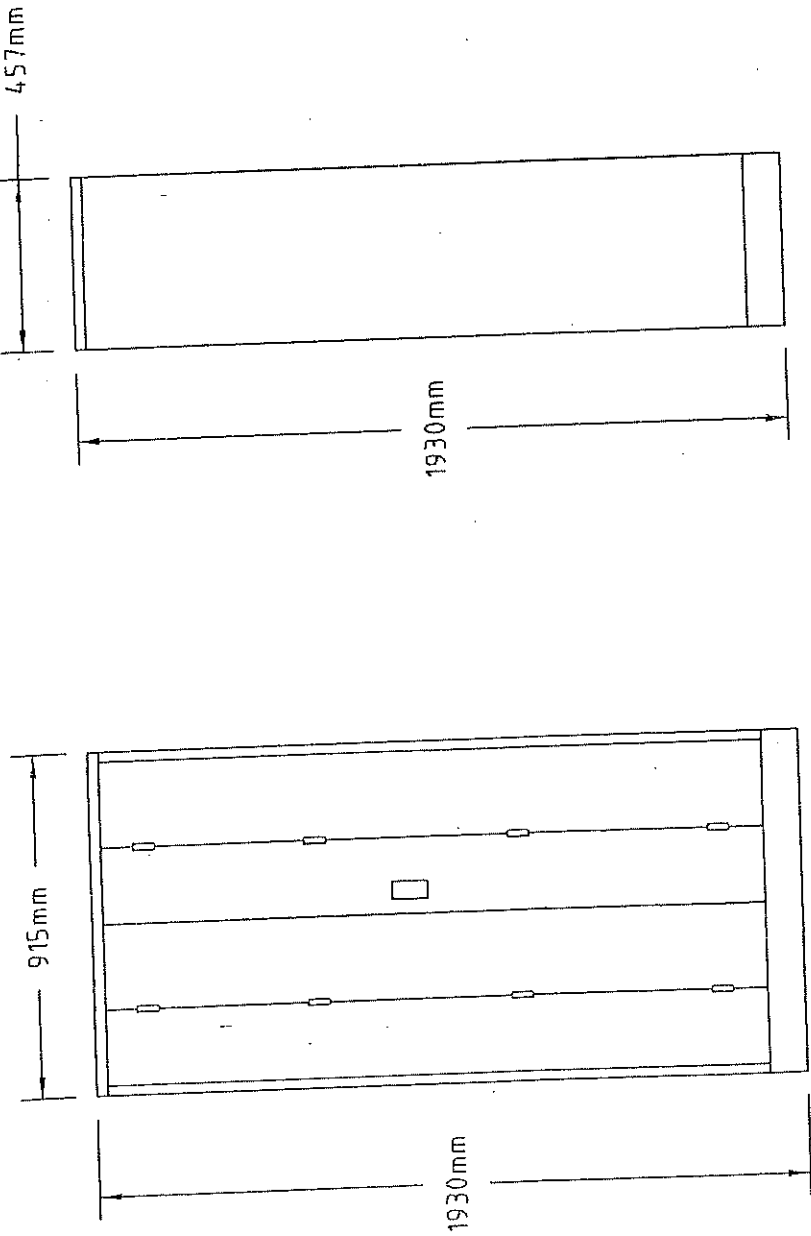

PANDANGAN ATAS

PANDANGAN SISI

PANDANGAN DEPAN

CATATAN:	SPESIFIKASI BAHAN		TARIKH	OLEH	SMK.
	KEPINGAN LOGAM 0.65/0.8/2.0MM				1
SEMUA STRUKTUR DILAPISI "EPOXY"	ANGGARAN +0.1 / -0.3				2
					3
					4
					5
			UKURAN : W915 X D457 X H1930mm		
TAJUK: LATERAL FILING CUPBOARD WITH 5 SETS LATERAL (SLF19)					
ND. LUKISAN:					
SKALA:					
ND. FAIL:					
BEBAS					

HALF HEIGHT OPEN DOOR CUPBOARD C/W 1 SHELF
HHO20

LAMPIRAN 12

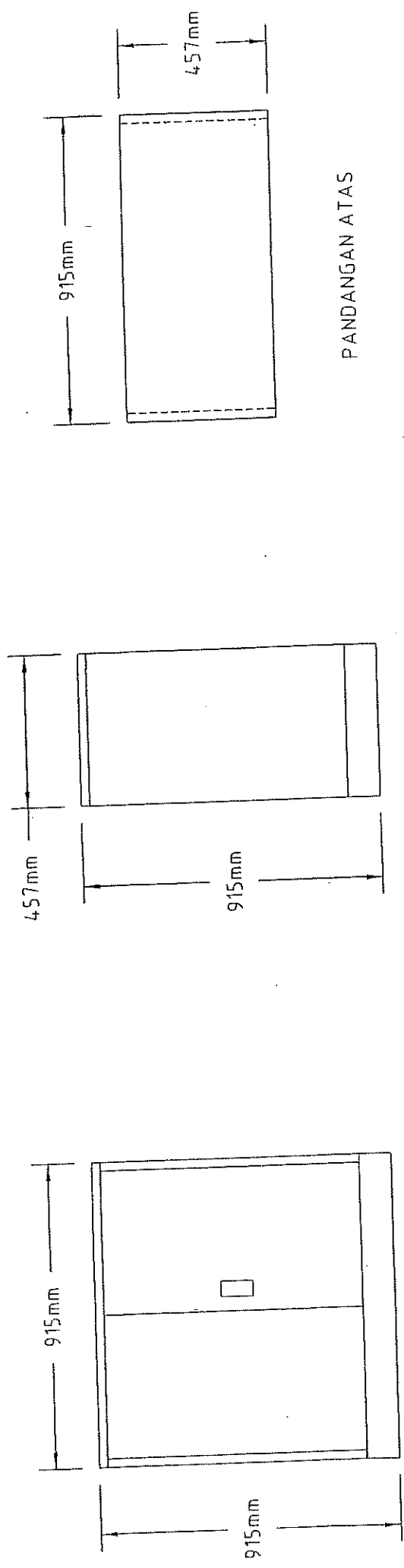

PANDANGAN DEPAN

PANDANGAN SISI

PANDANGAN ATAS

CATATAN:	SPESIFIKASI BAHAN		TARIKH	OLEH	SMK.
	1	2			
SEMUA STRUKTUR DILAPISI "EPOXY"	KEPINGAN LOGAM 0.65/0.8/2.0MM				1
					2
					3
					4
					5
TAJUK: HALF HEIGHT OPEN DOOR CUPBOARD C/W 1 SHELF (HHO20)					
NO. LUKISAN: SKALA: BEBAS					
NO. FAIL: ANGgaran -0.1 / -0.3					
UKURAN: W915 X D457 X H915mm					

HALF HEIGHT SLIDING DOOR CUPBOARD C/W 2 SHELVES

HSD21

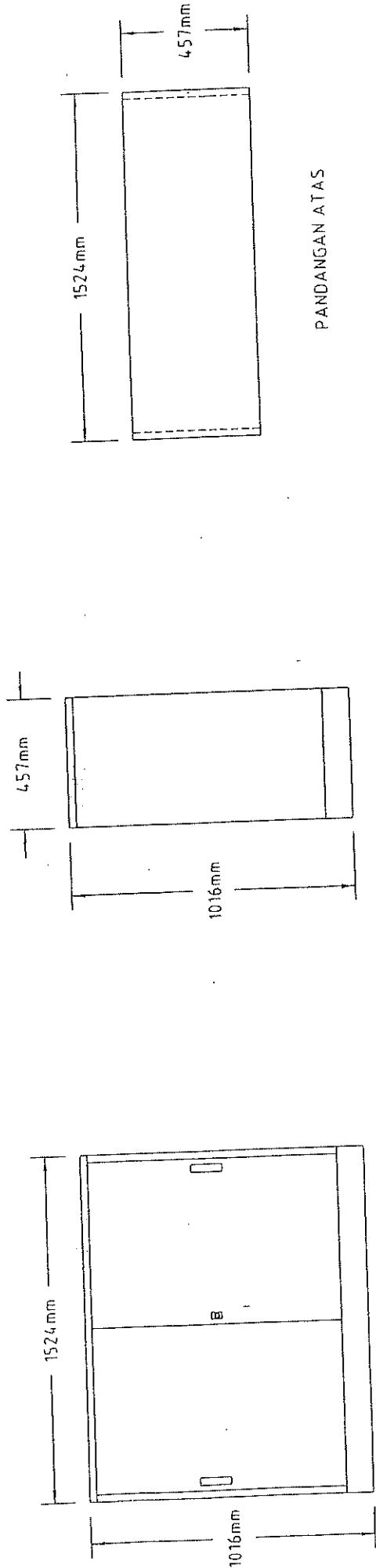

PANDANGAN DEPAN

PANDANGAN SISI

PANDANGAN ATAS

CATATAN:	SPESIFIKASI BAHAN		TARIKH	OLEH	SMK.
	Kepingan Logam 0.65/0.8/2.0mm				
SEMUA STRUKTUR DILAPISI "EPOXY"					1
					2
					3
					4
					5
TAJUK: HALF HEIGHT SLIDING DOOR CUPBOARD C/W 2 SHELVES (HSD21)					
NO. LUKISAN: SKALA: BEBAS					
NO. FAIL: ANGgaran +0.1 / -0.3					
UKURAN: W1219 X D457 X H1016mm					

HALF HEIGHT SLIDING GLASS DOOR CUPBOARD C/W 1 SHELF
HSG23

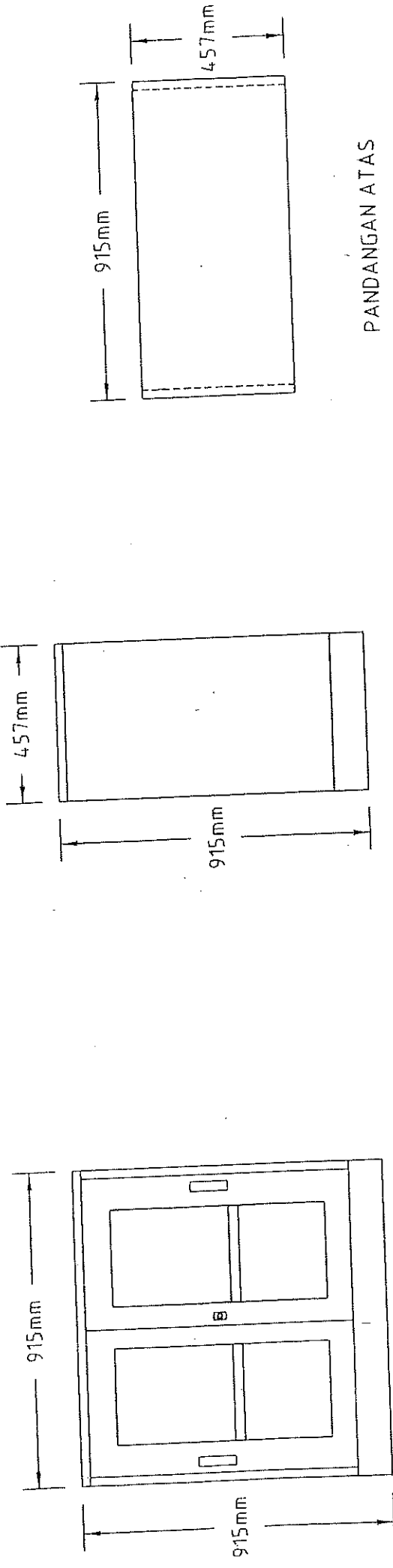

PANDANGAN SISI

PANDANGAN DEPAN

PANDANGAN ATAS

CATATAN:	SPESIFIKASI BAHAN		TARIKH	OLEH	SHK.
	SEMUA STRUKTUR DILAPISI "EPOXY"	KEPINGAN LOGAM 0.65/0.8/2.0MM			
UKURAN: W915 X D457 X H915mm	ANGGARAN +0.1 / -0.3		1		
			2		
			3		
			4		
			5		
TAJUK: HALF HEIGHT SLIDING GLASS DOOR CUPBOARD C/W 1 SHELF (HSG23)					
ND. LUKISAN:					
ND. FAIL:					
SKALA:					
BEBAS					

HALF HEIGHT SLIDING DOOR CUPBOARD C/W 1 SHELF

HSC24

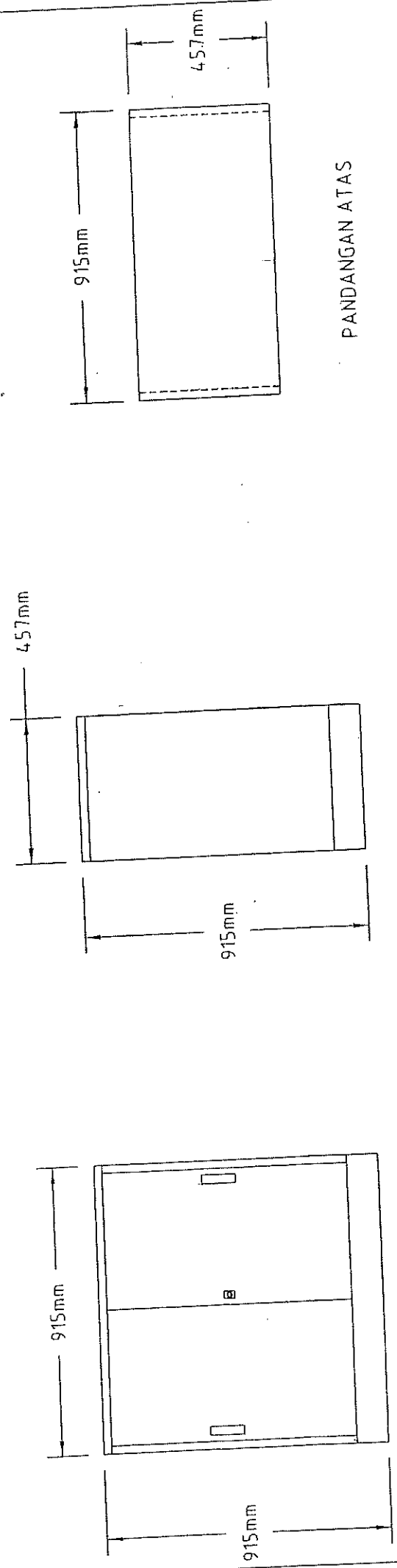

PANDANGAN DEPAN

PANDANGAN SISI

PANDANGAN ATAS

CATATAN:	SPESIFIKASI BAHAN		TARIKH	OLEH	SMK.
	KEPINGAN LOGAM 0.65/0.8/2.0MM				
SEMUA STRUKTUR DILAPISI "EPOXY"					1
					2
					3
					4
					5
TAJUK: HALF HEIGHT SLIDING DOOR CUPBOARD C/W 1 SHELF (HSC24)					
ND. LUKISAN:					
SKALA: BEBAS					
ND. FAIL:					
ANGgaran +0.1 / -0.3					
UKURAN: W915 X D457 X H915mm					

INGLE SIED PERIODICAL DISPLAY SHELVES (INDIVIDUAL BAY)

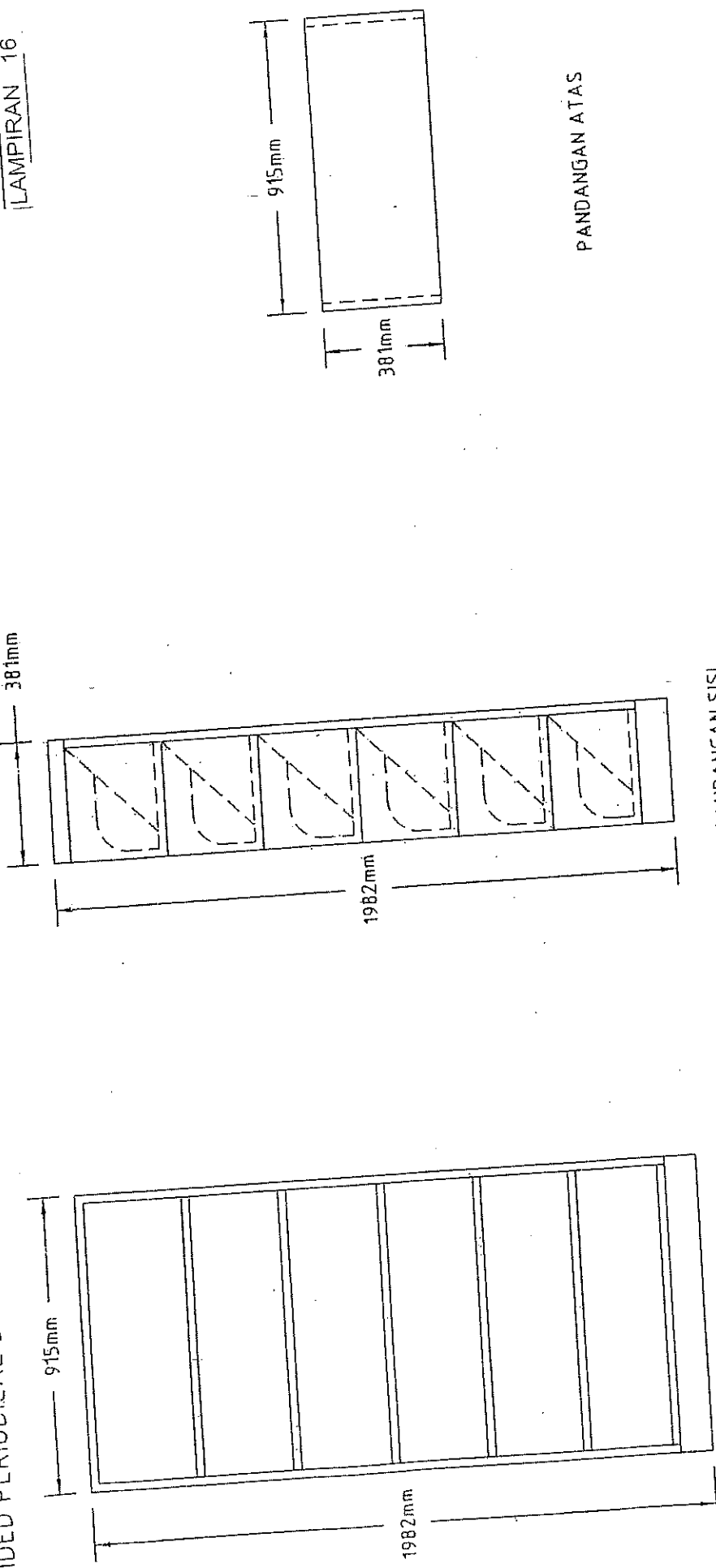

PANDANGAN ATAS

PANDANGAN SISI

PANDANGAN DEPAN

CATATAN: SEMUA STRUKTUR DILAPISI "EPOXY"	PANDANGAN DEPAN		PANDANGAN SISI	
	SPESIFIKASI BAHAN	TARIKH	OLEH	SMK.
SEMUA STRUKTUR DILAPISI "EPOXY"	KEPINGAN LOGAM 0.65/0.8/2.0MM			1
				2
				3
				4
				5
TAJUK: SINGLE SIDED PERIODICAL DISPLAY SHELVES (INDIVIDUAL BAY) (1P0131)				SKALA: BEBAS
NO. LUKISAN:				NO. FAIL:
UKURAN: W915 X D381 X H1982mm		ANGGARAN +0.1 / -0.3		

DOUBLE SIDED LIBRARY SHELVING (INDIVIDUAL BAY)

2DS129

LAMPIRAN 17

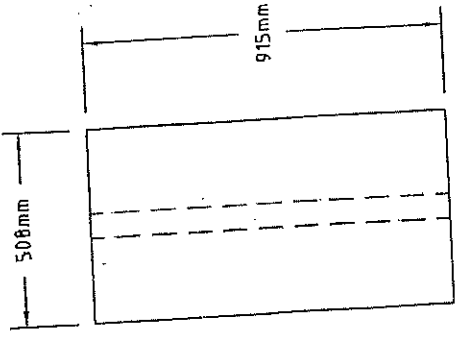
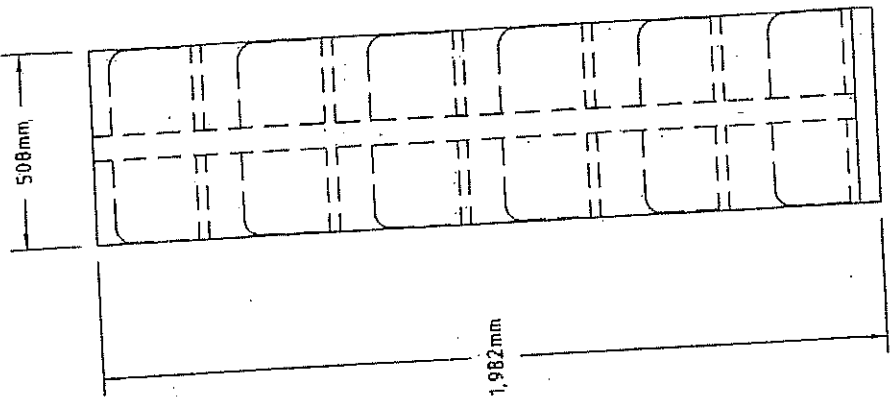
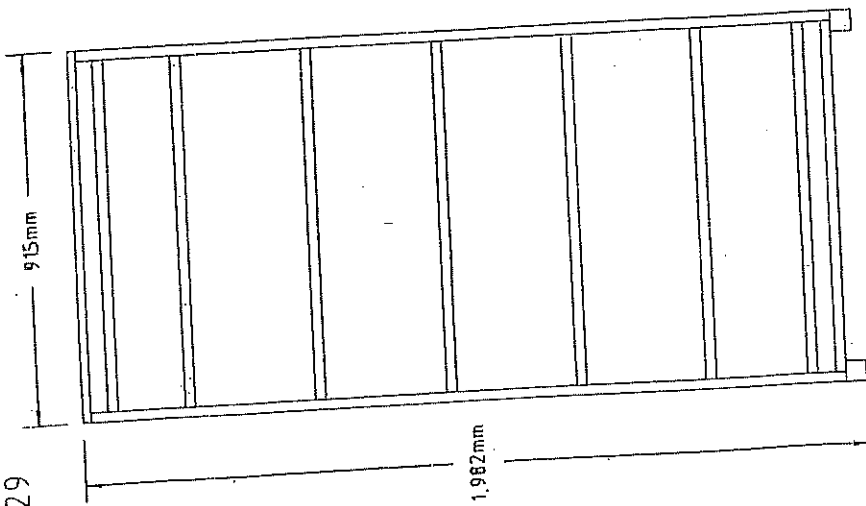

PANDANGAN DEPAN

PANDANGAN SISI

PANDANGAN ATAS

CATATAN:	SPESIFIKASI BAHAN		TARIKH	OLEH	SMK.	
	SEMUA STRUKTUR DILAPISI "EPOXY"	KEPINGAN LOGAM 0.65/0.8/2.0MM				1
<p>TAJUK: DOUBLE SIDED LIBRARY SHELVING (INDIVIDUAL BAY) (2DS129)</p>						
<p>NO. LUKISAN: NO. FAIL:</p>						
<p>SKALA: BEBAS</p>						
<p>UKURAN : W915 X D508 X H1982mm</p>						
<p>ANGGARAN +0.1 / -0.3</p>						

OPEN TYPE SHELIVING OTSf8

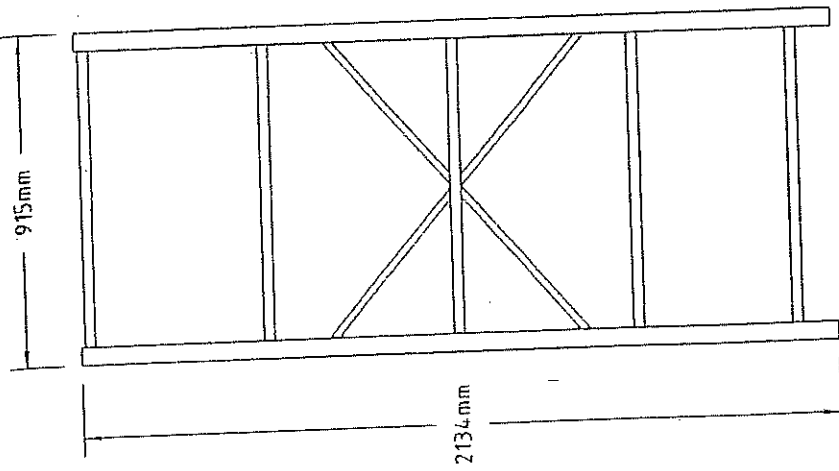

PANDANGAN DEPAN

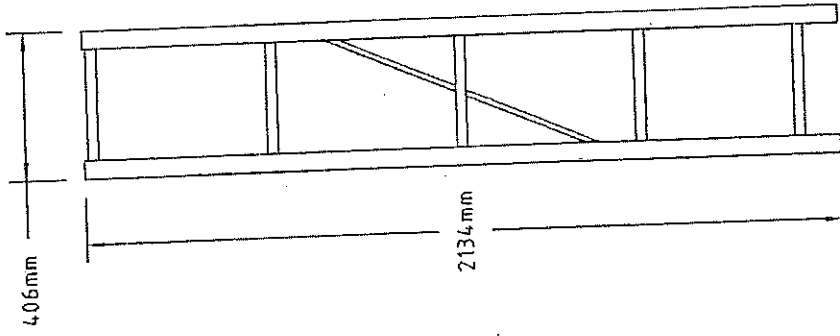

PANDANGAN SISI

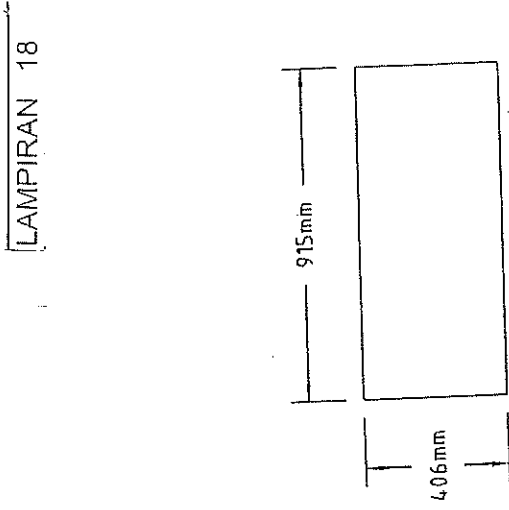

PANDANGAN ATAS

LAMPIRAN 18

CATATAN:	SPESIFIKASI BAHAN		TARIKH	OLEH	SHK.
	SEMUA STRUKTUR DILAPISI "EPOXY"	KEPINGAN LOGAM 0.65/0.8/2.0MM			
UKURAN : W915 X D406 X H2134mm					1
					2
					3
					4
					5
TAJUK: OPEN TYPE SHELIVING (OTSf8)					
NO. LUKISAN:					
SKALA: BEBAS					
NO. FAIL:					
ANGGARAN +0.1 / -0.3					

SINGLE COMPUTER TABLE
SCT35

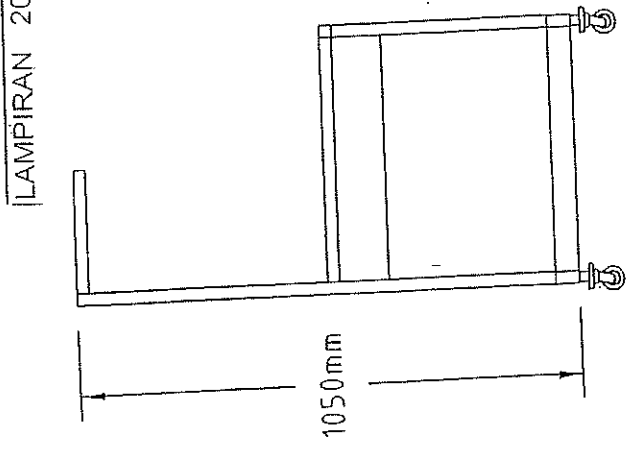
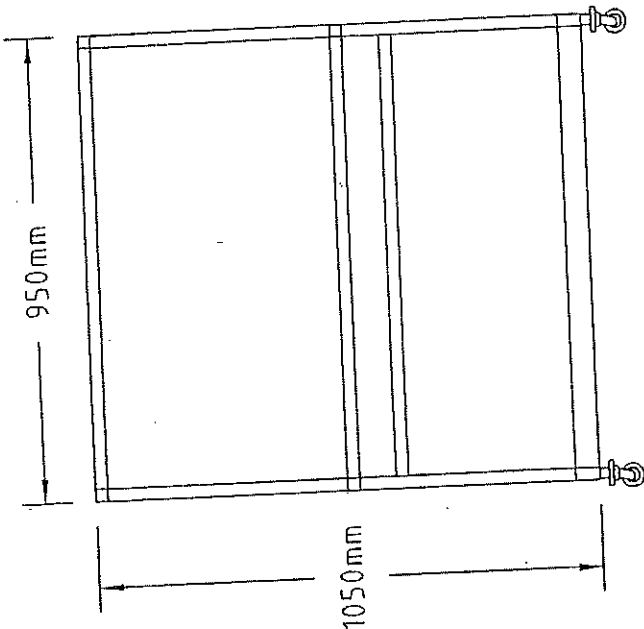
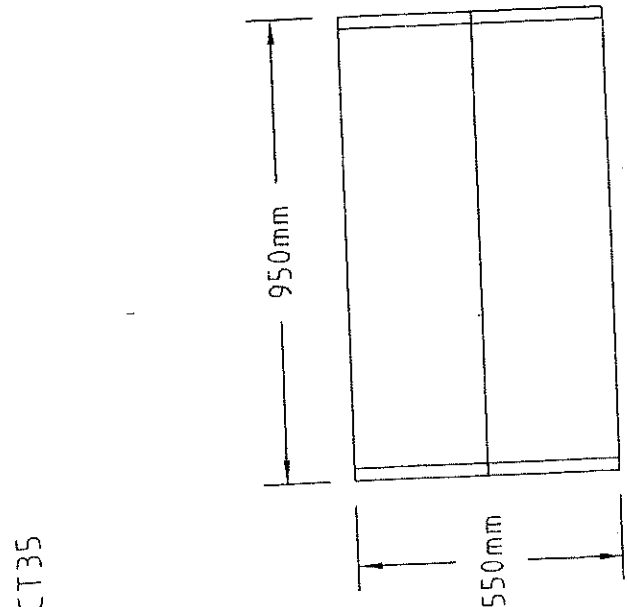

CATATAN:	SPESIFIKASI BAHAN				
	TARIKH	DLEH	SMK.		
SEMUA STRUKTUR DILAPISI "EPOXY"			1		
			2		
			3		
			4		
			5		
UKURAN : L950 X D550 X H1050mm			ANGGARAN +0.1 / -0.3		
TAJUK: SINGLE COMPUTER TABLE (SCT35)					
NO. LUKISAN:			SKALA: BEBAS		
NO. FAIL:					

DOUBLE PEDESTER DESK - 7 DRAWERS
7DP37

LAMPIRAN 21

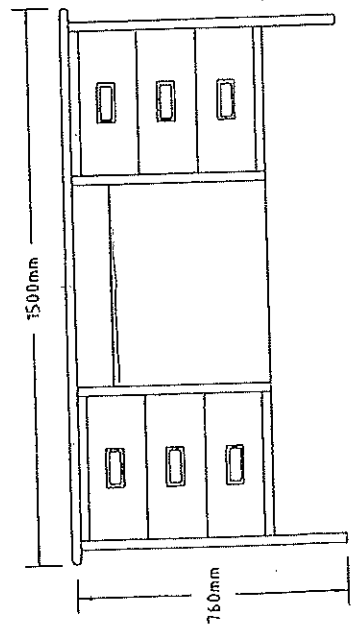

PANDANGAN DEPAN

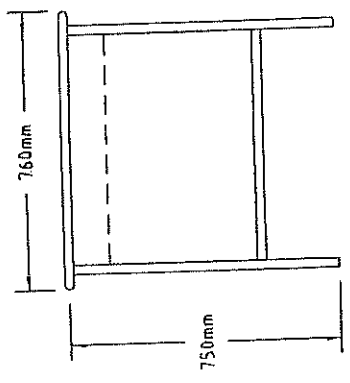

PANDANGAN SISI

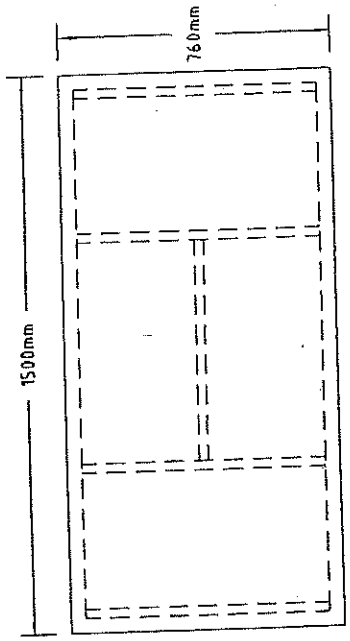

PANDANGAN ATAS

UKURAN : W150 X D760 X H760mm
CHIPBOARD HIGH PRESSURE LAMINATE
POST - FORMED TOP

CATATAN:	SPESIFIKASI BAHAN		TARIKH	OLEH	SMK.
	1	2			
SEMUA STRUKTUR DILAPISI "EPOXY"	KEPINGAN LOGAM 0.65/0.8/2.0MM				1
					2
					3
					4
UKURAN : W391 X D385 X H1828mm	ANGGARAN +0.1 / -0.3				5
TAJUK: DOUBLE PEDESTER DESK - 7 DRAWERS (7DP37)					
				NO. LUKISAN:	
				SKALA: BEBAS	
				NO. FAIL:	

SINGLE PEDESTAL DESK - 4 DRAWERS
4DSP38

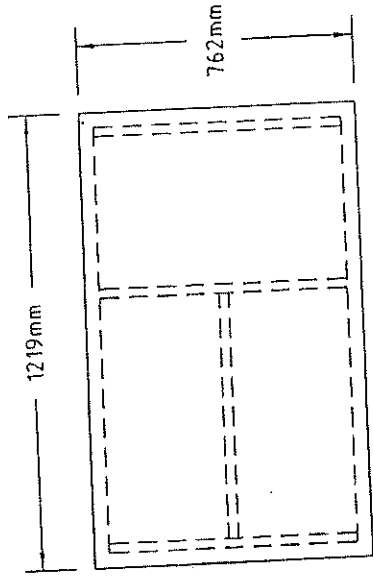

PANDANGAN ATAS

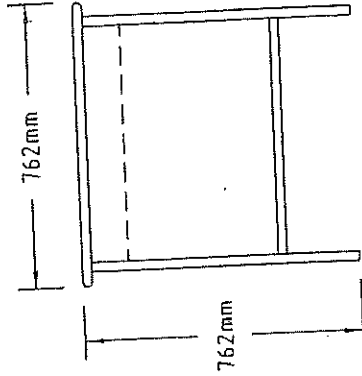

PANDANGAN SISI

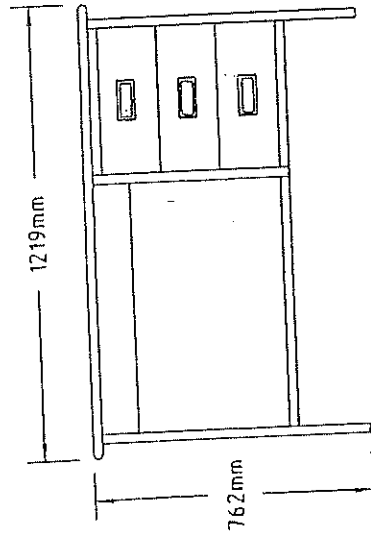

PANDANGAN DEPAN

CATATAN:	SPESIFIKASI BAHAN		TARIKH	OLEH	SMK.								
	SEMUA STRUKTUR DILAPISI "EPOXY"	KEPINGAN LOGAM 0.65/0.8/2.0MM				1	2	3	4	5			
UKURAN: W1200 X D760 X H760mm	ANGGARAN +0.1 / -0.3												
TAJUK: SINGLE PEDESTAL DESK - 4 DRAWERS (4DSP38)						NO. LUKISAN:		SKALA:		BEBAS			
						NO. FAIL:							

WRITING TABLE C/W MELAMINE TOP,
MOBILE PEDESTAL & COMPUTER TRAY.

WT40

LAMPIRAN 23

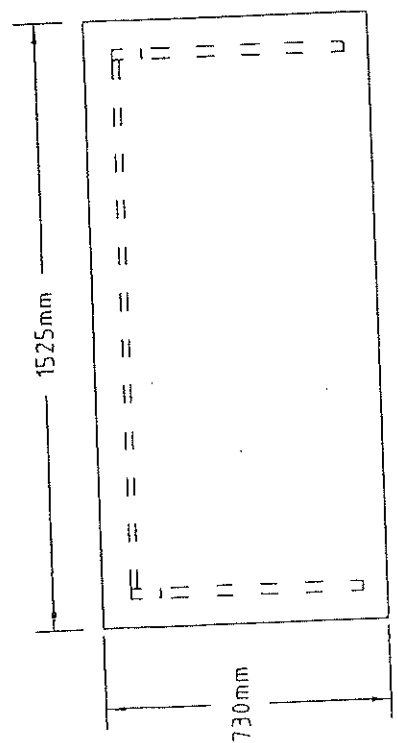

PANDANGAN ATAS

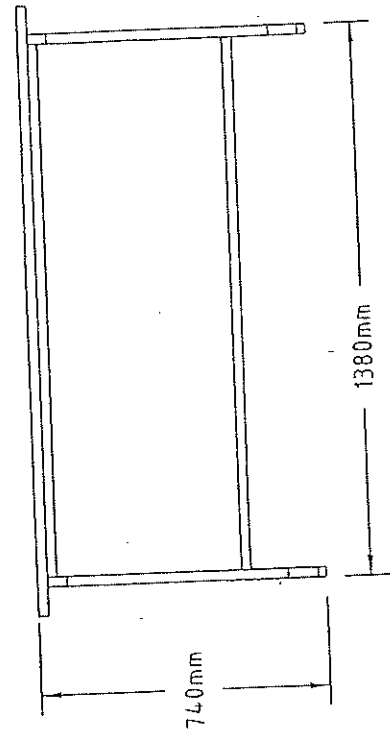

PANDANGAN HADAPAN

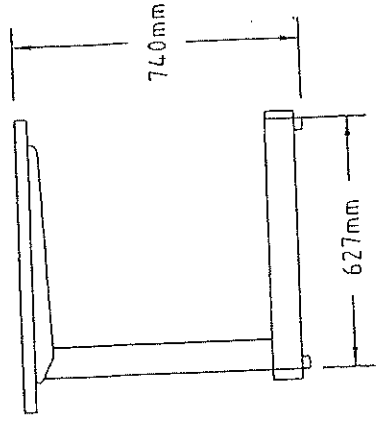

PANDANGAN SISI

CATATAN:	SPESIFIKASI BAHAN		TARIKH	OLEH	SHK.
	1	2			
SEMUA STRUKTUR DILAPISI "EPOXY"	KEPINGAN LOGAM 0.65/0.8/2.0MM				1
					2
					3
					4
					5
TAJUK: WRITING TABLE C/W MELAMINE TOP (WT40)					
NO. LUKISAN:					
NO. FAIL:					
SKALA: BEBAS					
LUKURAN : L1500 X D760 X HT160mm	ANGGARAN +0.1 / -0.3				

WRITING TABLE C/W MELAMINE TOP
 CENTER DRAWER & HANGING 2 DRAWER
 PEDESTAL
 WT41

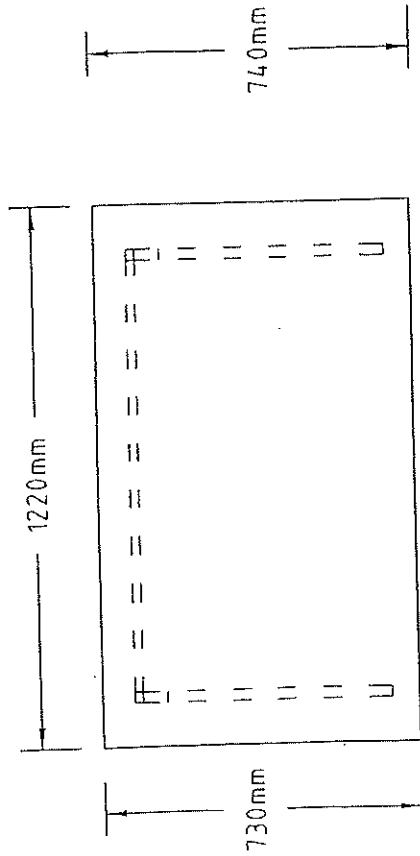

PANDANGAN ATAS

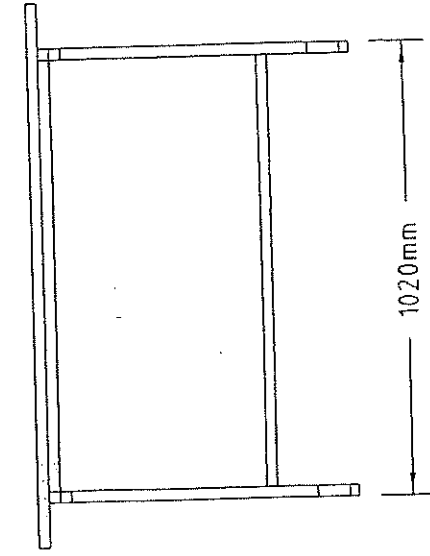

PANDANGAN HADAPAN

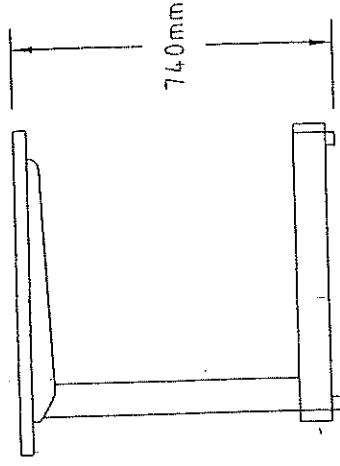

PANDANGAN SISI

CATATAN:	SPESIFIKASI BAHAN		TARIKH	OLEH	SMK.
	SEMUA STRUKTUR DILAPISI "EPOXY"	KEPINGAN LOGAM 0.65/0.8/2.0MM			
UKURAN : L1200 X D760 X H760mm					1
					2
					3
					4
					5
TAJUK: WRITING TABLE C/W MELAMINE TOP (WT41)					
NO. LUKISAN:					
SKALA: BEBAS					
NO. FAIL:					

FOLD-AWAY RECTANGLE TABLE (A)
FRT42

PANDANGAN ATAS

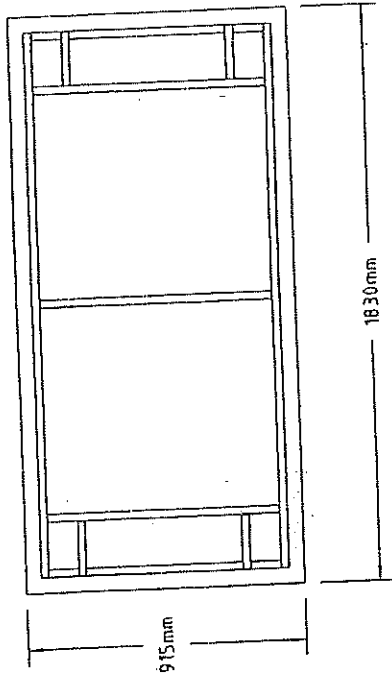
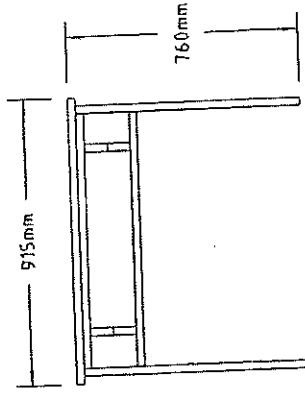
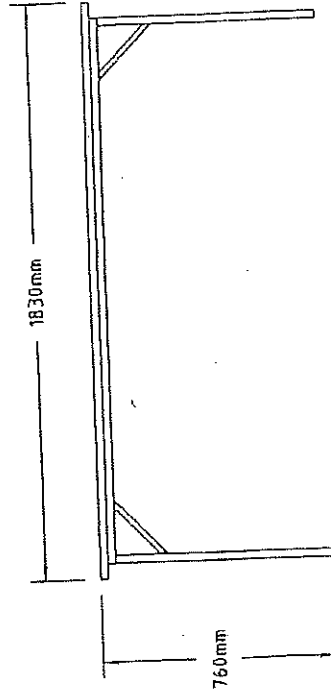

TABLE TOP: MAICA LAMINATED TOP
C/W PU EDGING
LEG BASE: MILDSTEEL BLACK EPOXY
COLLAPSIBLE BASE

PANDANGAN SISI



PANDANGAN DEPAN



CATATAN:	SPESIFIKASI BAHAN		TARIKH	OLEH	SMK.
	SEMUA STRUKTUR DILAPISI "EPOXY"	KEPINGAN LOGAM 0.65/0.8/2.0MM			
UKURAN : W915 X D1830 X H760mm					1
					2
					3
					4
					5
TAJUK: FOLD-AWAY RECTANGLE TABLE (A) (FRT42)					
NO. LUKISAN: NO. FAIL:					
SKALA: BEBAS					

ANGGARAN +0.1 / -0.3

FOLDAWAY RECTANGLE TABLE (B)
FRT43

LAMPIRAN 26

PANDANGAN ATAS

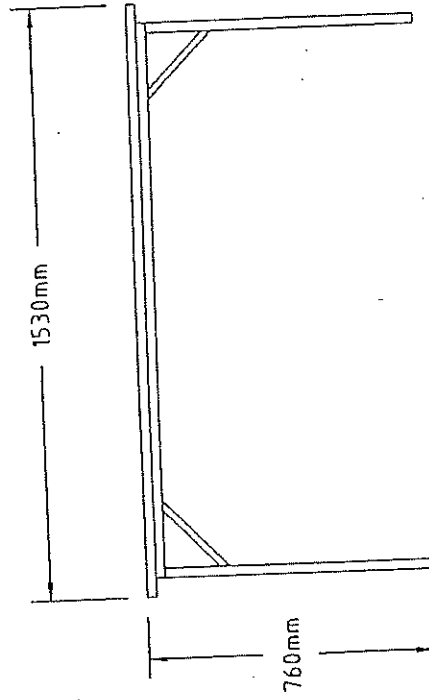
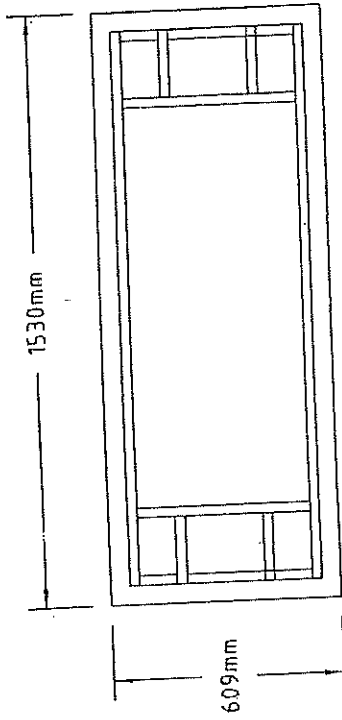

PANDANGAN DEPAN

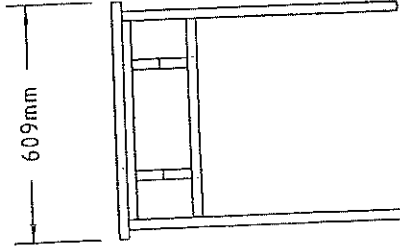

PANDANGAN SISI

TABLE TOP: MAICA LAMINATED TOP
C/W PU EDGING
LEG BASE: MILDSTEEL BLACK EPOXY
COLLAPSIBLE BASE

CATATAN:	SPESIFIKASI BAHAN		TARIKH	OLEH	SMK.
	SEMUA STRUKTUR DILAPISI "EPOXY"	KEPINGAN LOGAM 0.65/0.8/2.0MM			
					1
					2
					3
					4
					5
TAJUK: FOLDAWAY RECTANGLE TABLE (B) (FRT43)					
NO. LUKISAN: SKALA:					
NO. FAIL: BEBAS					
UKURAN : W609 X D1530 X H760mm ANGGARAN +0.1 / -0.3					

OFFICER WARDROBE
OW47

LAMPIRAN 27

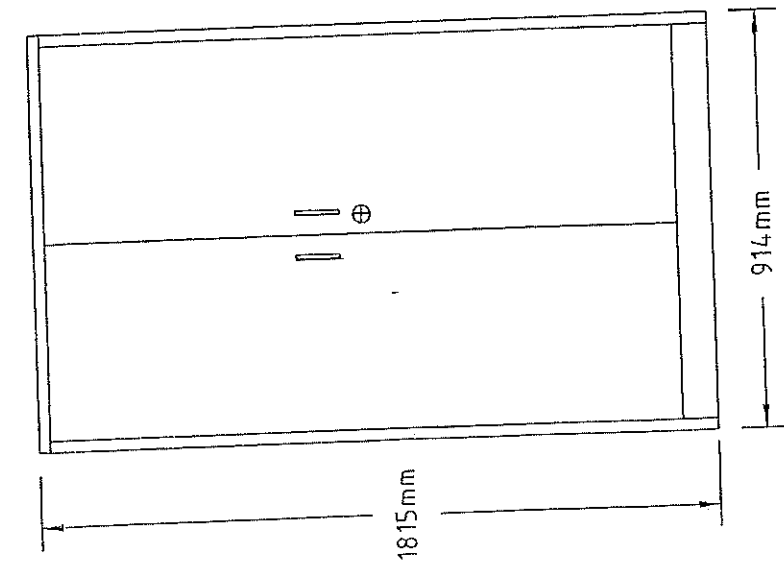

PANDANGAN HADAPAN

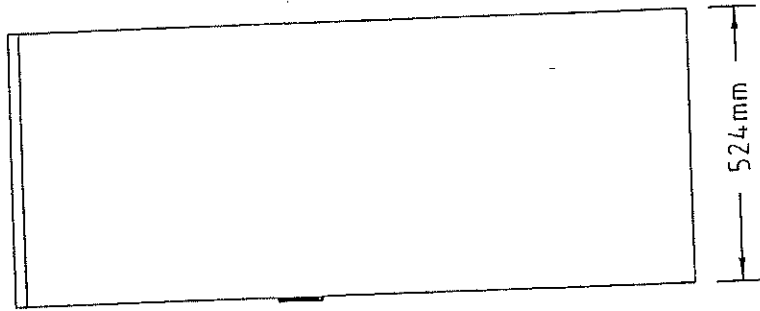

PANDANGAN SISI

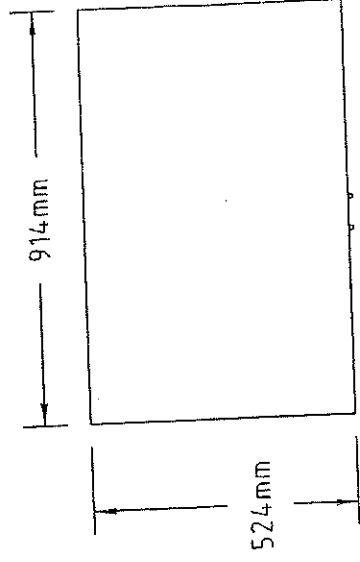

PANDANGAN ATAS

CATATAN:	SPESIFIKASI BAHAN		TARIKH	OLEH	SMK.
	SEMUA STRUKTUR DILAPISI "EPOXY"	KEPINGAN LOGAM 0.65/0.8/2.0MM			
UKURAN : W524 X D914 X H1815mm	TOLERANSI : ±0.3				4
					5
TAJUK: OFFICER WARDROBE (OW47)					
NO. LUKISAN:					
SKALA: BEBAS					

25 DOORS LOCKER (SECONDARY SCHOOL)
25DS49

LAMPIRAN 28

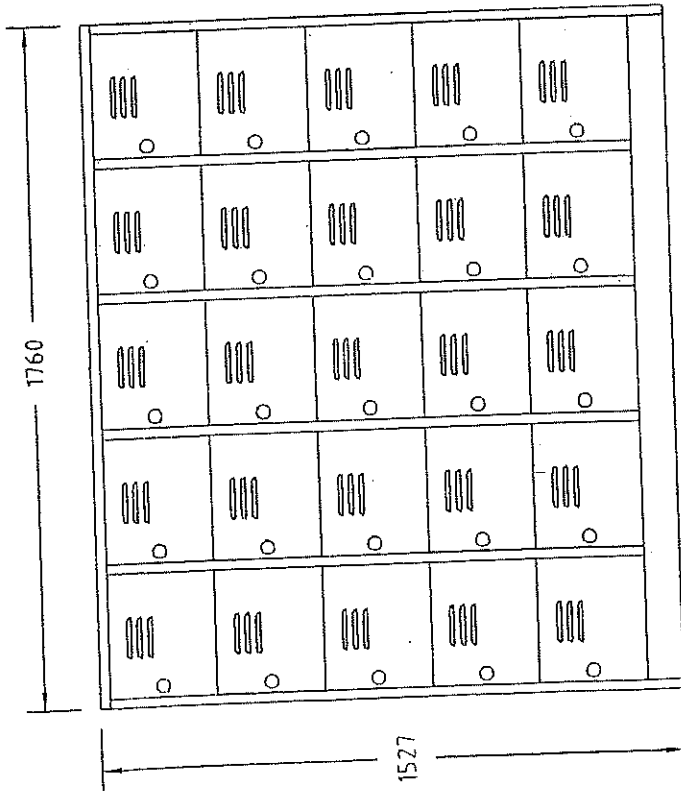

PANDANGAN HADAPAN

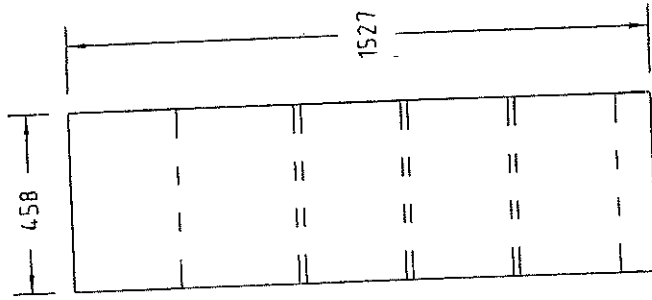

PANDANGAN SISI

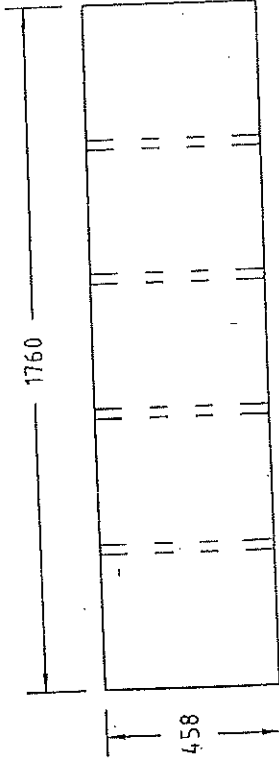

PANDANGAN ATAS

CATATAN:	SPESIFIKASI BAHAN		TARIKH	OLEH	SMK.
	KEPINGAN LOGAM 0.65/0.8/2.0MM				
SEMUA STRUKTUR DILAPISI "EPOXY"					1
					2
					3
					4
					5
TAJUK: 25 DOORS LOCKER (SECONDARY SCHOOL) (25DS49)					
NO. LUKISAN: SKALA: BEBAS					
UKURAN : W391 X D385 X H1828mm ANGGARAN +0.1 / -0.3					

STAFF LOCKER STF50

LAMPIRAN 29

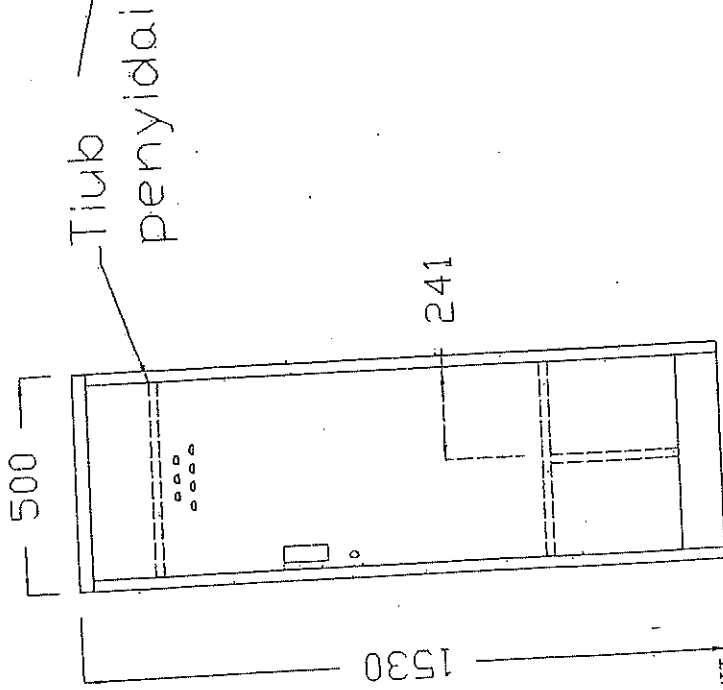

Pandangan Depan

AKSESORI :
SKRU & NAT 1"=4 UNIT
TOMBOL PINTU = 1 PCS
"CAM LOCK" = 1 UNIT
ENSEL = 3 UNIT

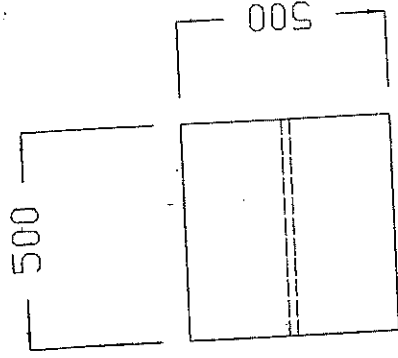

Pandangan Atas

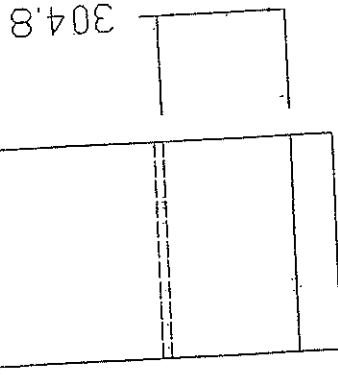

Pandangan Sisi

CATATAN:	SPESIFIKASI BAHAN:		TARIKH	DLEH	SMK	TAJUK :	SKALA :
	KEPINGAN LOGAM 0.65/1.0/2.0MM	TIUB BULAT 19MM					
						STAFF LOCKER	ND. LUKISAN :
							ND. FAIL :
SEMUA UKURAN DALAM MM KECUALI DINYATAKAN						ANGGARAN C 17-03	

LAMPIRAN 30

LAMPIRAN 30

TRAINEE LOCKER TL51

PANDANGAN ATAS

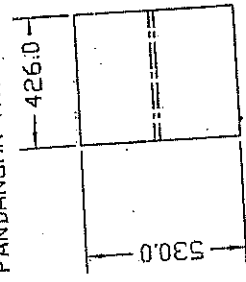

TIUB PENYIDAI

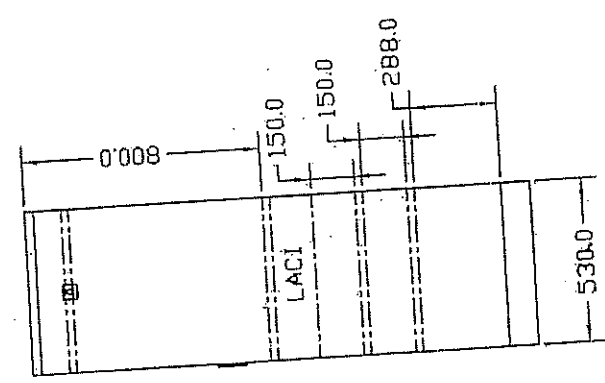
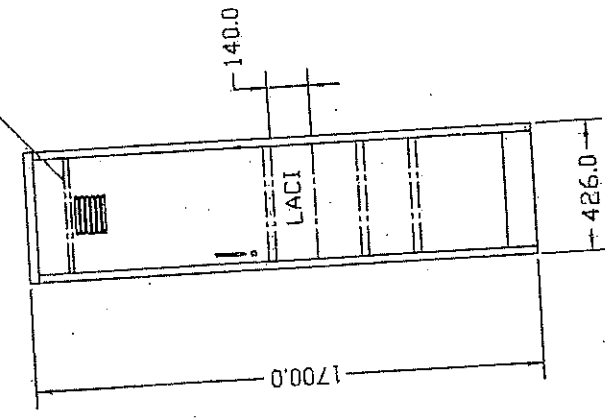

PANDANGAN SISI

PANDANGAN HADAPAN

- AKSESORI
- SKRU & NUT 1" - 4 UNIT
- CAH LOCK - 1 UNIT
- TOMBOL PINTU - 1 UNIT
- ENSEL - 3 UNIT

CATATAN	SPESIFIKASI BAHAN	TARIKH	OLEH	SMC	TARIKH		TAJUK: TL51	SKALA:
					NO. LUKISAN	NAMA FAIL		
	KEPINGAN LOGAM BESHM, 1.2MM L			1				
	2MMH			2				
	TIUB BULAT 1.9MM			3				
				4				
				5				
SEMUA UKURAN DALAM MM KECUALI DINYATAKAN	ANGGARAN +DL / -0.3							

LAMPIRAN 31

1 COMPARTMENT LOCKER 1CL52

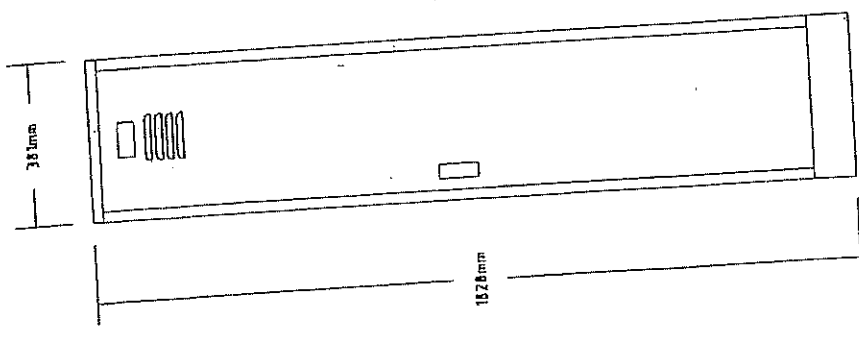

PANDANGAN DEPAN

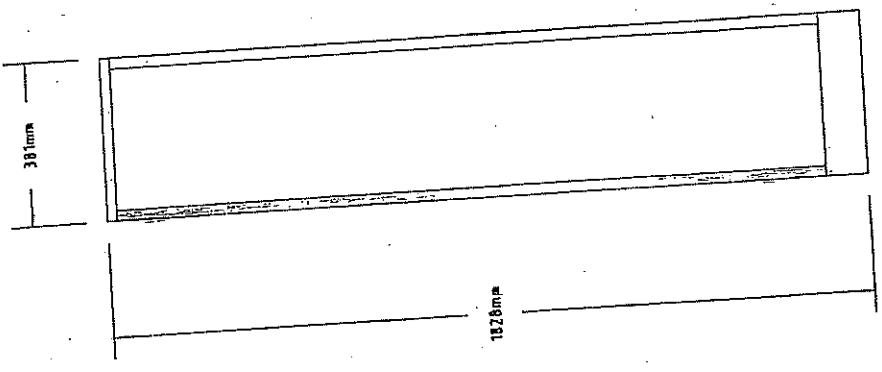

PANDANGAN SISI

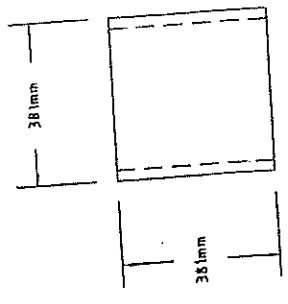

PANDANGAN ATAS

CATATAN:

SEMUA STRUKTUR DILAPISI "EPOXY"

UKURAN : W391 X D385 X H1828mm

SPEKIFIKASI BAHAN

KEPINGAN LOGAM 0.65/0.8/2.0MM

ANGGARAN +0.1 / -0.3

PANDANGAN DEPAN		PANDANGAN SISI		PANDANGAN ATAS	
TARIKH	OLEH	SMK.	TARIKH	OLEH	SMK.
		1			
		2			
		3			
		4			
		5			

TAJUK:
1 COMPRTMENT LOCKER (1CL52)

NO. LUKISAN:

SKALA:

BEBAS

NO. FAIL:

2 COMPARTMENT LOCKER
2CL53

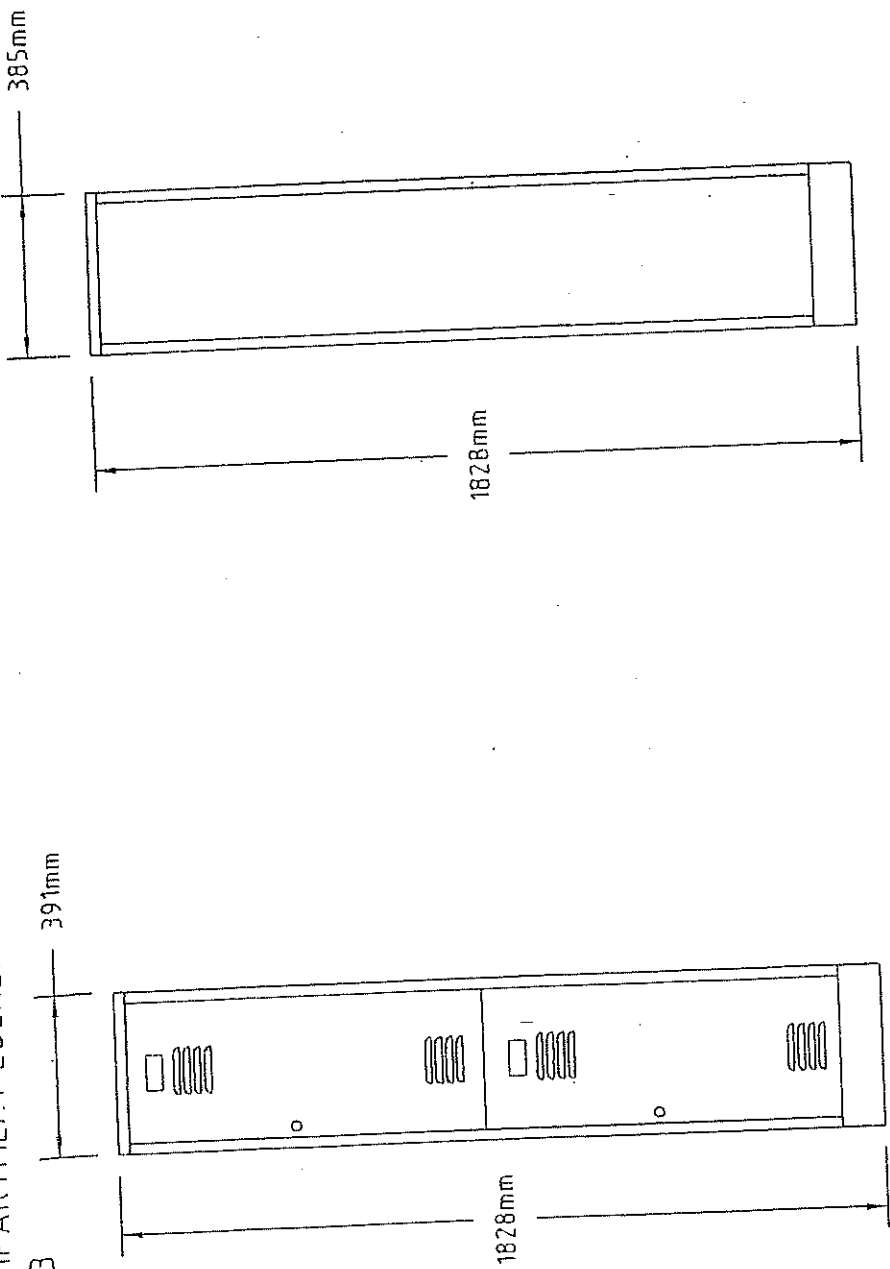

PANDANGAN ATAS

PANDANGAN SISI

PANDANGAN DEPAN

CATATAN:	SPESIFIKASI BAHAN		TARIKH	OLEH	SHK.
	Kepingan Logam 0.85/0.8/72.0MM				
SEHUA STRUKTUR DILAPISI "EPOXY"					1
					2
					3
					4
					5
TAJUK: 2 COMPARTMENT LOCKER (2CL53)					
SKALA: BEBAS					
ND. LUKISAN:					
NO. FAIL:					
UKURAN : 1/391 X 0385 X H1828mm					
ANGGARAN +0.1 / -0.3					

4 COMPARTMENT LOCKER
4CL55

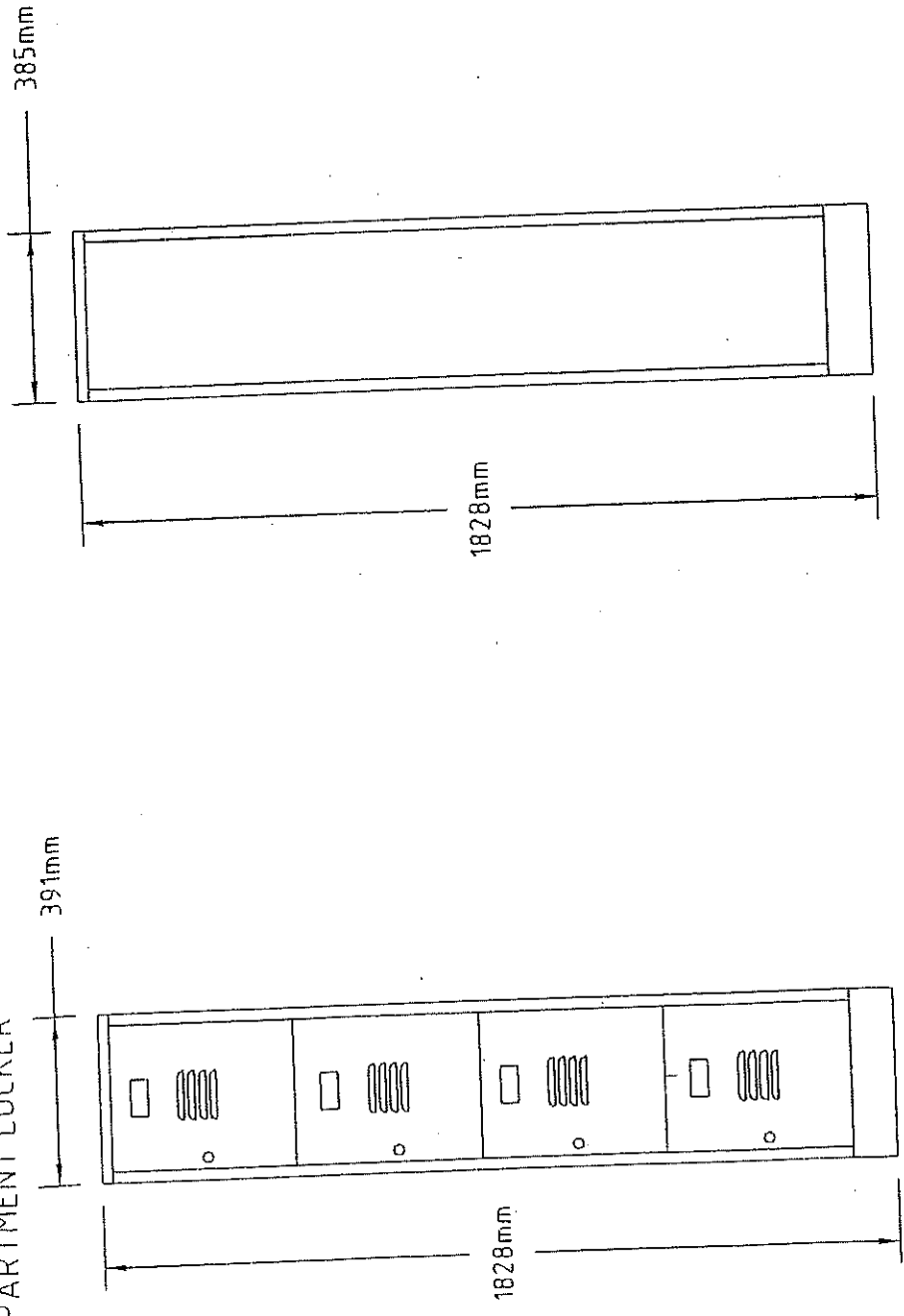

PANDANGAN ATAS

PANDANGAN SISI

PANDANGAN DEPAN

CATATAN:	SPESIFIKASI BAHAN	TARIKH	OLEH	SMK.	PANDANGAN SISI	
					NO. LUKISAN:	SKALA:
SEMUA STRUKTUR DILAPISI "EPOXY"	KEPINGAN LOGAM 0.65/0.8/2.0MM			1		TAJUK: 4 COMPARTMENT LOCKER (4CL55)
				2		
				3		
				4		
				5		
UKURAN : W391 X D385 X H1828mm	ANGGARAN +0.1 / -0.3					

3 TIERS LETTER RACK
3LR58

LAMPIRAN 34

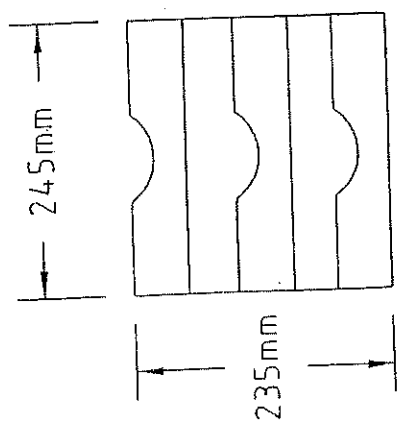
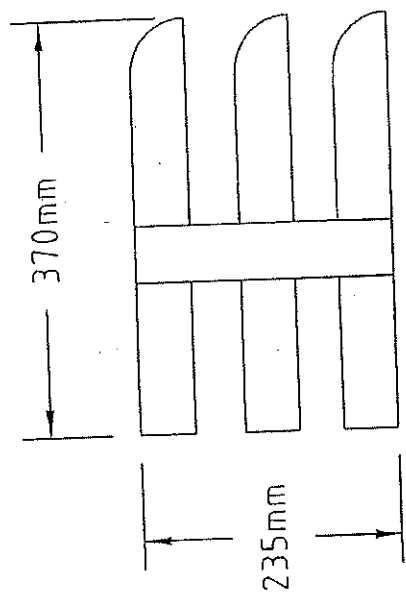
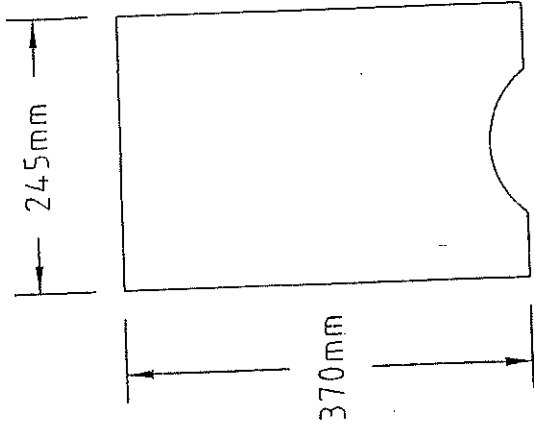

PANDANGAN ATAS

PANDANGAN SISI

PANDANGAN DEPAN

CATATAN:	SPESIFIKASI BAHAN		TARIKH	OLEH	SMK.
	Kepingan Logam 0.65/0.8/2.0mm				
SEMUA STRUKTUR DILAPISI "EPOXY"					1
					2
					3
					4
					5
TAJUK: 3 TIERS LETTER RACK (BLSB)					
NO. LUKISAN:					
SKALA: BEBAS					
NO. FAIL:					
UKURAN: W245 X D370 X H235mm	ANGGARAN +0.1 / -0.3				

SIDE TABLE C/W 9 HOLES
9HST63

LAMPIRAN 35-36

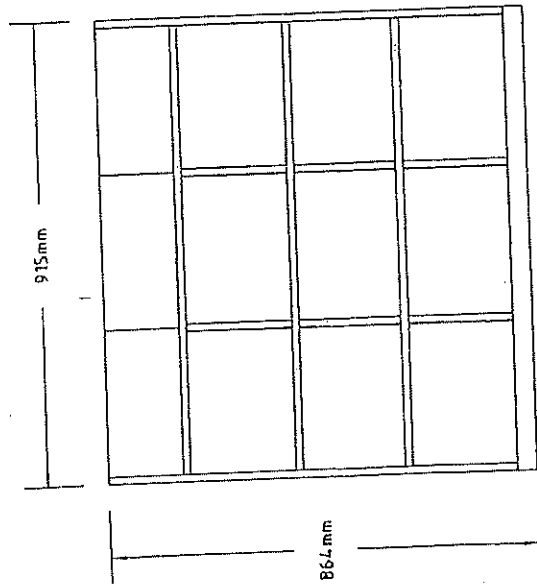

PANDANGAN DEPAN

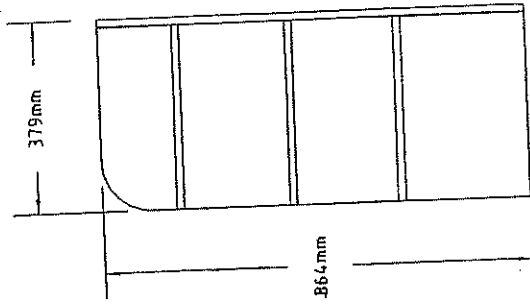

PANDANGAN SISI

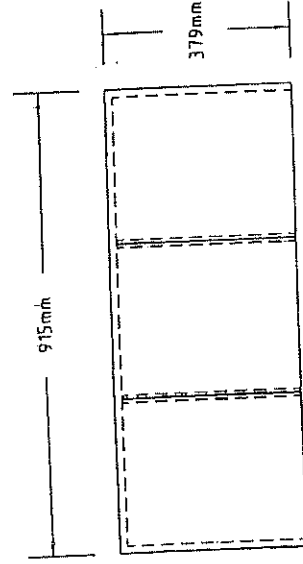

PANDANGAN ATAS

CATATAN:	SPESIFIKASI BAHAN		TARIKH	OLEH	SMK.
	KEPINGAN LOGAM 0.65/0.8/2.0MM				
SEMUA STRUKTUR DILAPISI "EPOXY"					1
					2
					3
					4
					5
UKURAN: W915 X D379 X H864mm		ANGGARAN +0.1 / -0.3			

TAJUK:
SIDE TABLE C/W 9 HOLES (9HST63)

NO. LUKISAN:
NO. FAIL:
SKALA:
BEBAS

BOOK TROLLEY WITH FLATE SHELVES BTF64

LAMPIRAN 37

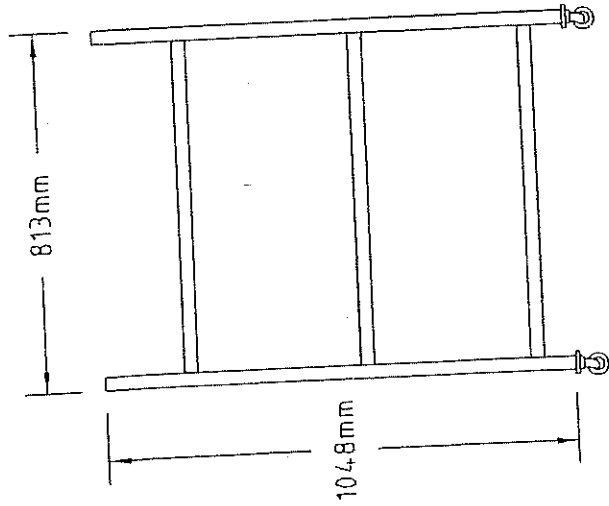

PANDANGAN DEPAN

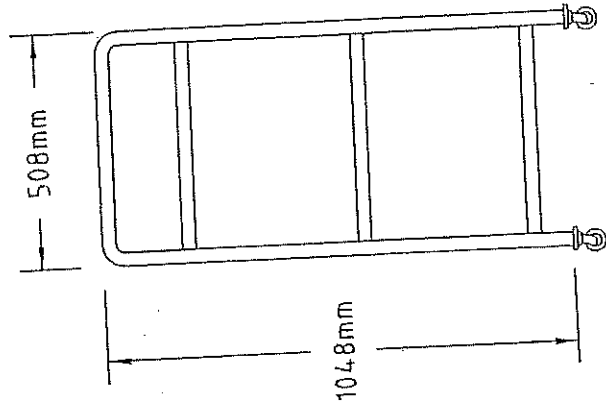

PANDANGAN SISI

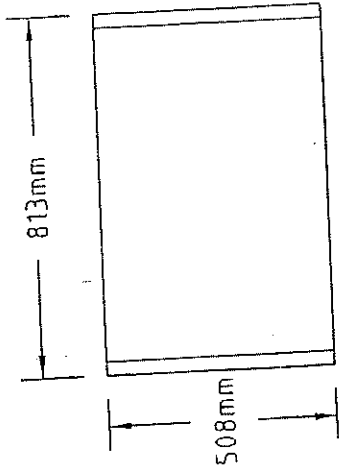

PANDANGAN ATAS

CATATAN:		SPESIFIKASI BAHAN		TARIKH	OLEH	SMK.
SEMUA STRUKTUR DILAPISI "EPOXY"		KEPINGAN LOGAM 0.65/0.8/2.0MM				1
						2
						3
						4
						5
UKURAN : W813 X D508 X H1048mm		ANGGARAN +0.1 / -0.3				
TAJUK: BOOK TROLLEY WITH FLATE SHELVES (BTF64)						
NO. LUKISAN: SKALA: BEBAS						
NO. FAIL: BEBAS						

BOOK TROLLEY WITH SLOPING SHELVES
BTF65

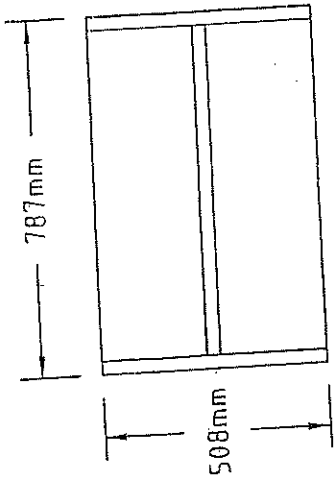

PANDANGAN ATAS

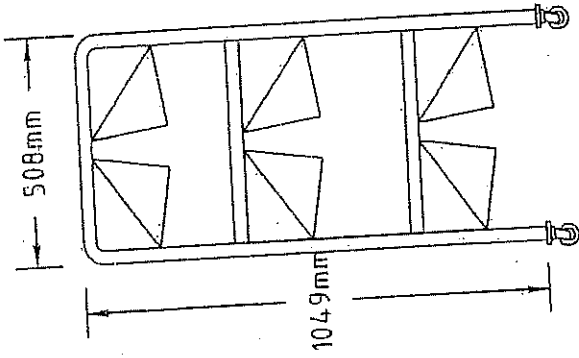

PANDANGAN SISI

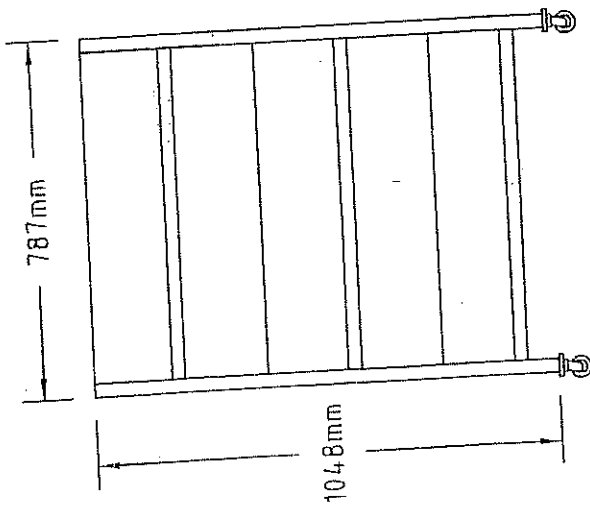

PANDANGAN DEPAN

CATATAN:	SPESIFIKASI BAHAN		TARIKH	OLEH	SMK.
	SEMUA STRUKTUR DILAPISI "EPOXY"	KEPINGAN LOGAM 0.65/0.8/2.0MM			
UKURAN : W787 X D508 X H1048mm	TAJUK: BOOK TROLLEY WITH SLOPING SHELVES (BTF65)		1		
	NO. LUKISAN:		2		
	NO. FAIL:		3		
	SKALA: BEBAS		4		
			5		
ANGGARAN +0.1 / -0.3					

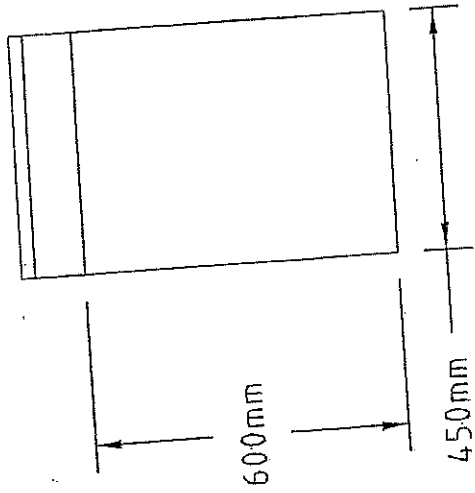
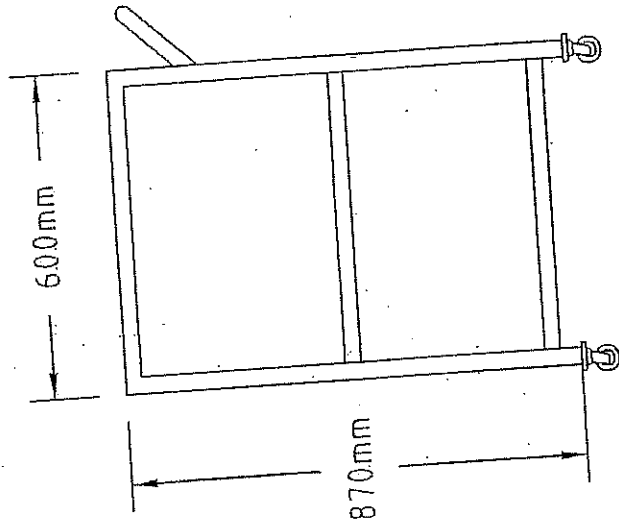
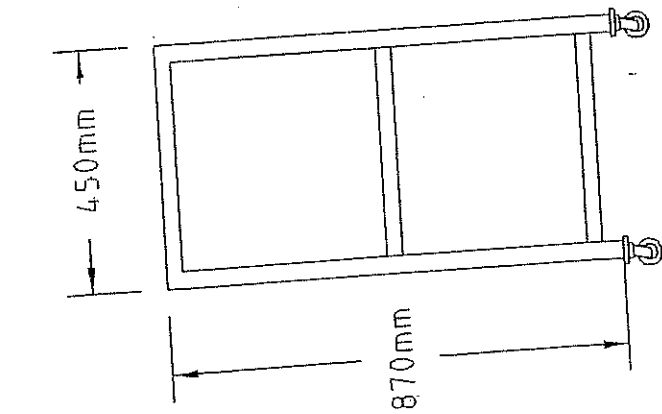

PANDANGAN DEPAN

PANDANGAN SISI

PANDANGAN ATAS

CATATAN:	SPESIFIKASI BAHAN		TARIKH	OLEH	SMK.
	SEMUA STRUKTUR DILAPISI "EPOXY"	KEPINGAN LOGAM 0.65/0.8/2.0MM			
UKURAN : W450 X D600 X H870mm	ANGGARAN +0.1 / -0.3				5
					4
					3
					2
					1
TAJUK: PROJECTOR TROLLEY (PT67)					
NO. LUKISAN: NO. FAIL:					
SKALA: BEBAS					

OPEN TYPE SHELVING OTS68

LAMPIRAN 40

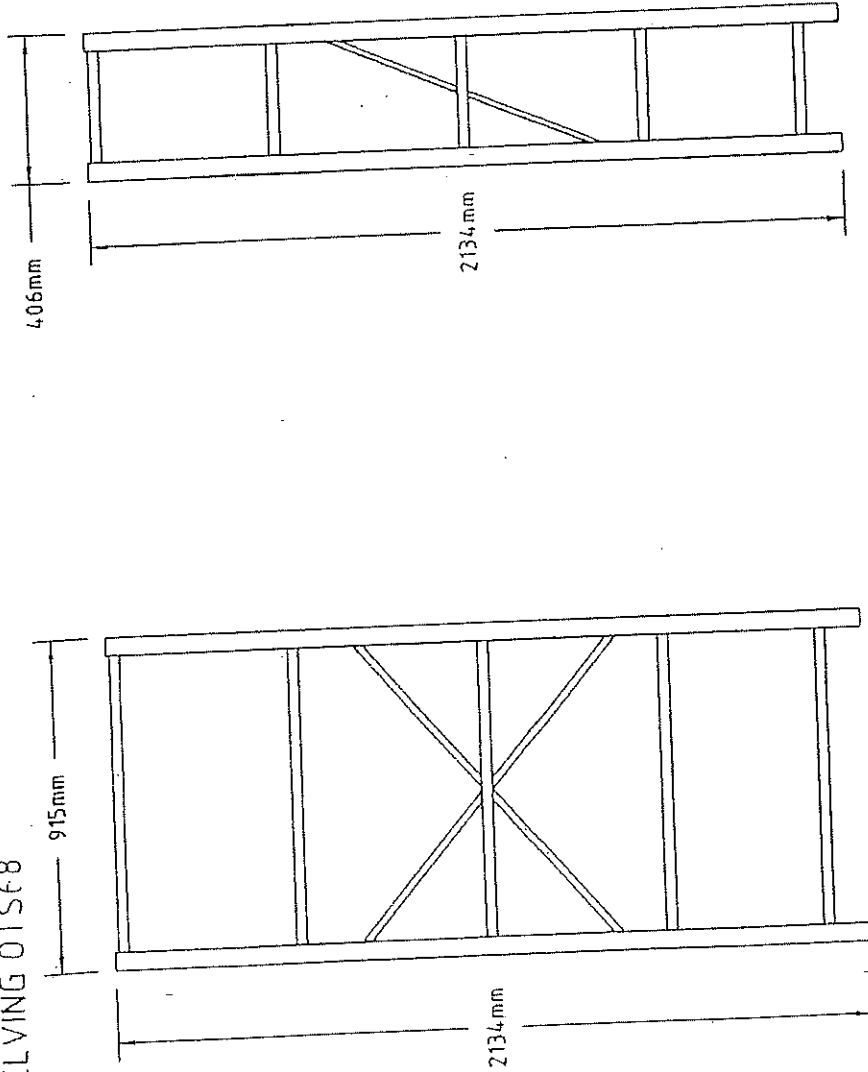

PANDANGAN DEPAN

PANDANGAN SISI

PANDANGAN ATAS

CATATAN:	SPESIFIKASI BAHAN		TARIKH	OLEH	SMK.
	Kepingan Logam 0.6570.B/2.0MM				
SEMUA STRUKTUR DILAPISI "EPOXY"					1
					2
					3
					4
					5
TAJUK: OPEN TYPE SHELVING (OTS68)					
NO. LUKISAN:					
NO. FAIL:					
SKALA: BEBAS					
ANGGAHAN +0.1 / -0.3					
UKURAN : W915 X D406 X H2134mm					

CLOSED TYPE SHELVING CTS69

LAMPIRAN 41

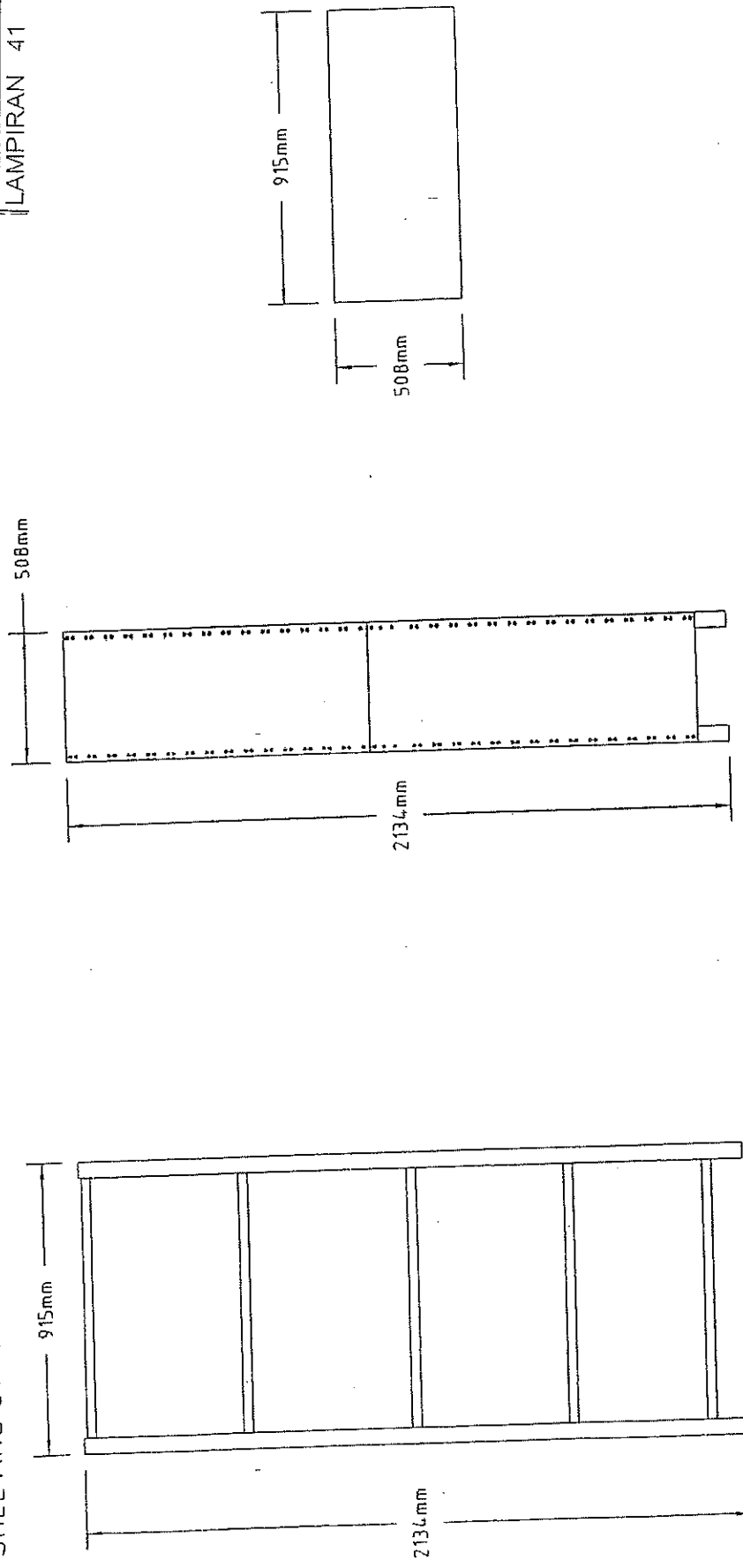

PANDANGAN HADAPAN

PANDANGAN SISI

PANDANGAN ATAS

CATATAN:	SPESIFIKASI BAHAN		TARIKH	OLEH:	SHK.
	SEMUA STRUKTUR DILAPISI "EPOXY"	KEPINGAN LOGAM 0.65/0.8/2.0MM			
UKURAN : W915 X D508 X H2134mm	ANGGARAN -0.1 / -0.3				1
					2
					3
					4
					5
TAJUK: CLOSED TYPE SHELVING (CTS69)					
NO. LUKISAN:					
NO. FAIL:					
SKALA: BEBAS					

STUDY TABLE WITH LAMINATED TOP
ST78

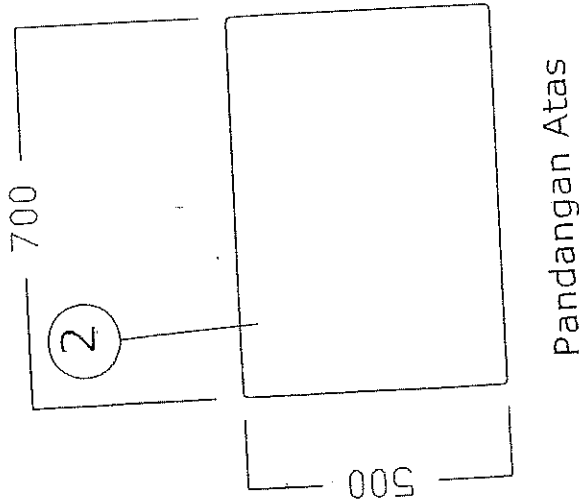
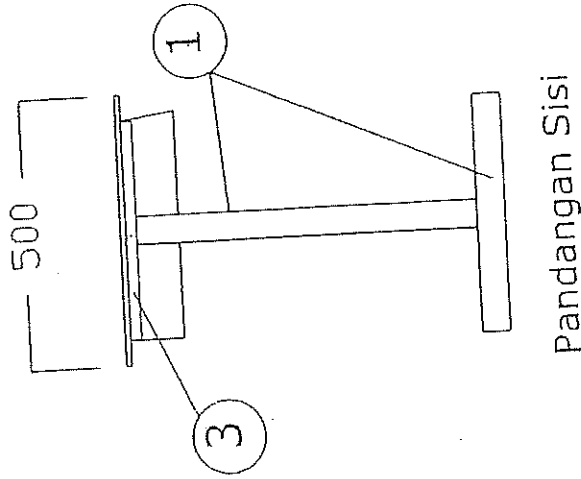
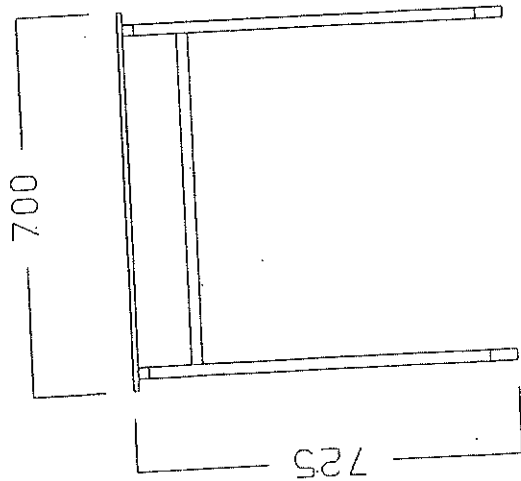

CATATAN:	SPESIFIKASI BAHAN:		TARIKH	DILEH	SMK
	1-Rectangular Hollow Section 50 x 25 x 1.2mm	2-Laminated Top 500 x 700 x 15mm			
SEMUA STRUKTUR DILAPISI "EPOXY"	3-Square Hollow Section 25 x 25 x 1mm				1
					2
					3
					4
					5

TAJUK :
STUDY TABLE WITH LAMINATED TOP

SKALA :
NO. LUKISAN :
NO. FAIL :

ANGGARAN 0.1/-0.3

UKURAN W700 X D500 X H725

STUDY CHAIR SC79

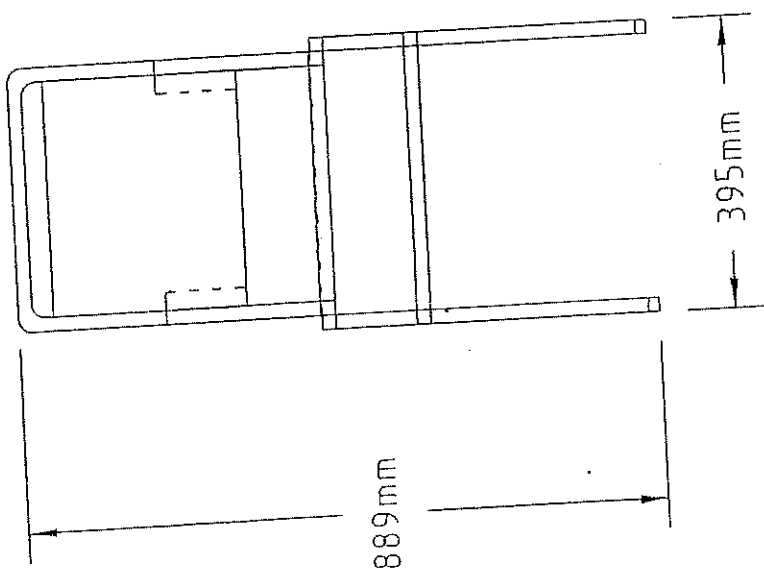

PANDANGAN HADAPAN

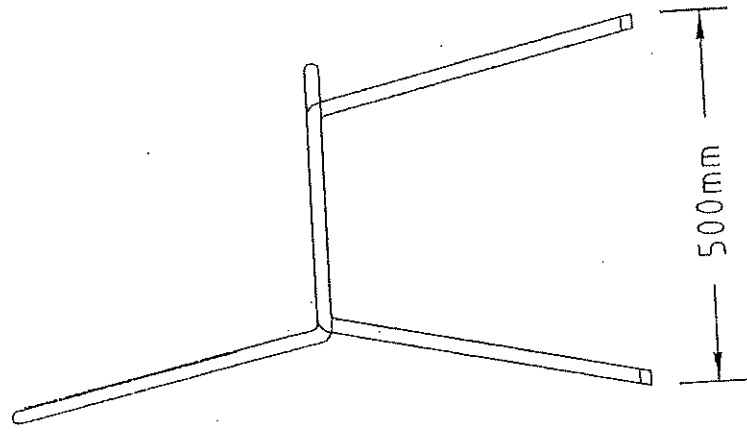

PANDANGAN SISI

CATATAN:	SPESIFIKASI BAHAN		TARIKH	OLEH	SMK.
	SEMUA STRUKTUR DILAPISI "EPOXY"	KEPINGAN LOGAM 0.65/0.8/2.0MM			
UKURAN : W385 X D465 X H889mm					1.
					2.
					3.
					4.
					5.
TAJUK: STUDY CHAIR (SC79)					
NO. LUKISAN: SKALA:					
NO. FAIL: BEBAS					
ANGGARAN +0.1 / -0.3					

LABORATORY STOOL WITH CUSHION (HIGH)
LSC81

LAMPIRAN 44

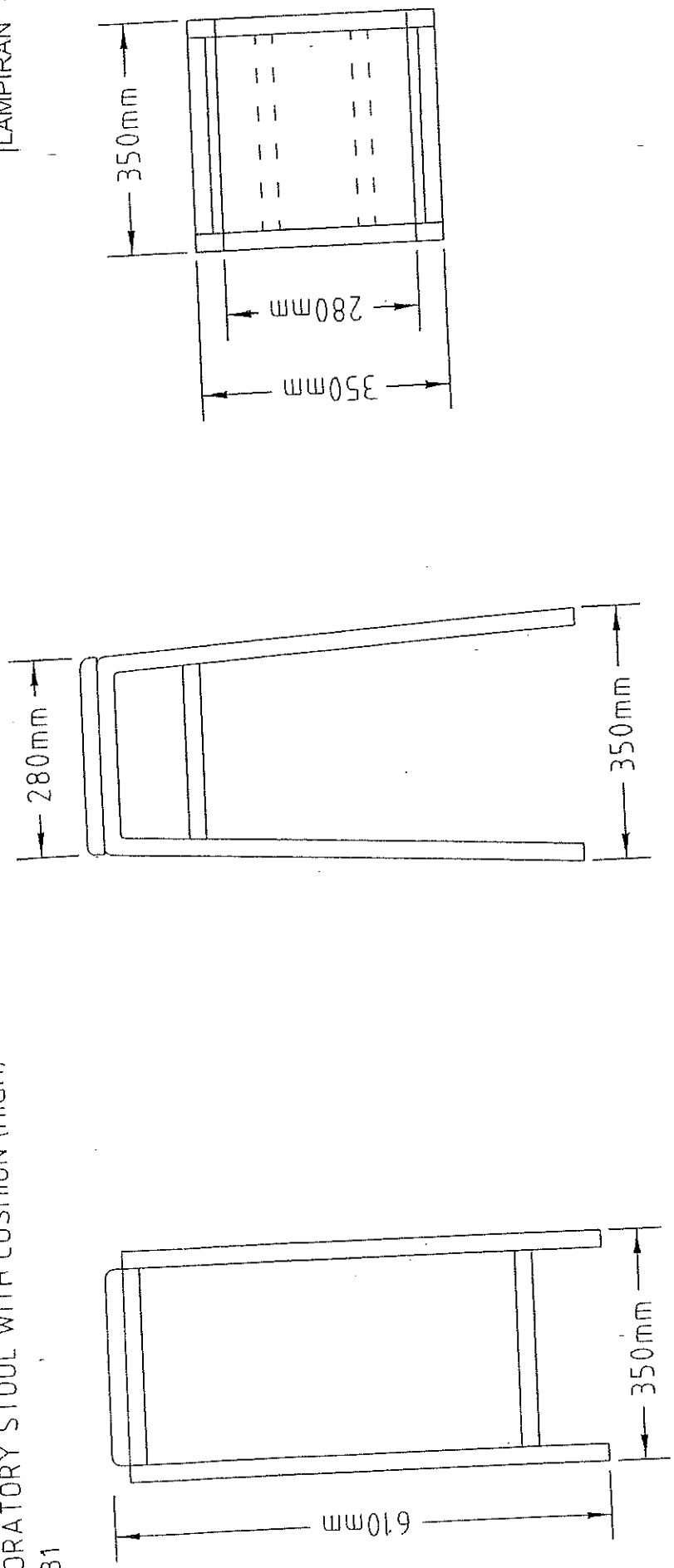

PANDANGAN HADAPAN

PANDANGAN SISI

PANDANGAN ATAS

CATATAN:	SPESIFIKASI BAHAN		TARIKH	OLEH	SMK.	
	SEMUA STRUKTUR DILAPISI "EPOXY"	KEPINGAN LOGAM 0.65/0.8/2.0MM				1
UKURAN : W350 X D350 X H610mm	ANGGARAN +0.1 / -0.3				4	5
TAJUK: LABORATORY STOOL WITH CUSHION (HIGH) (LSC81)						
NO. LUKISAN:						
SKALA: BEBAS						

SCHOOL BENCH
SB86

LAMPIRAN 45

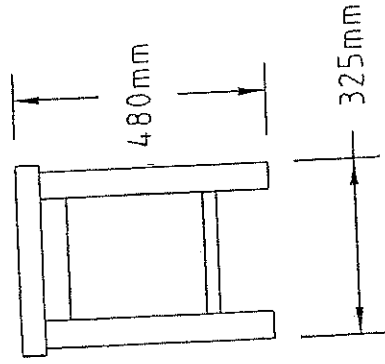
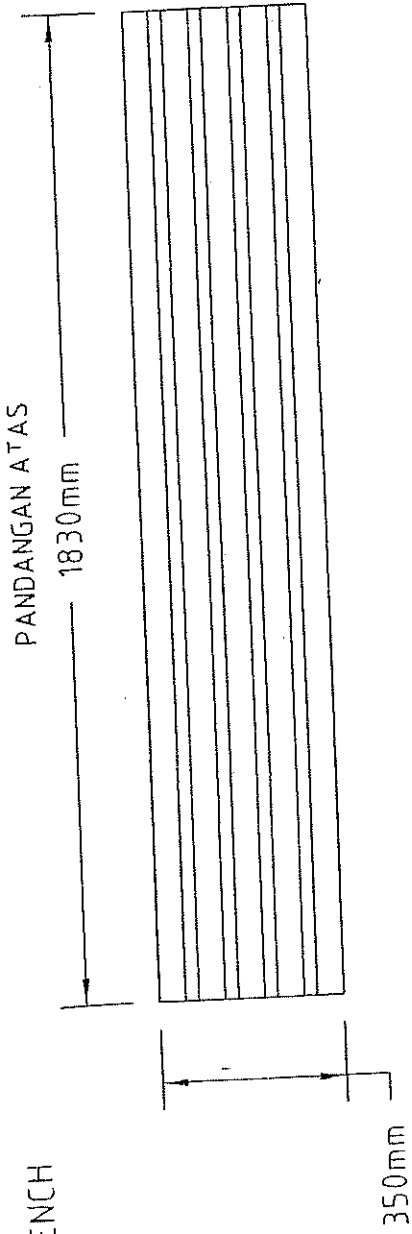

PANDANGAN SISI

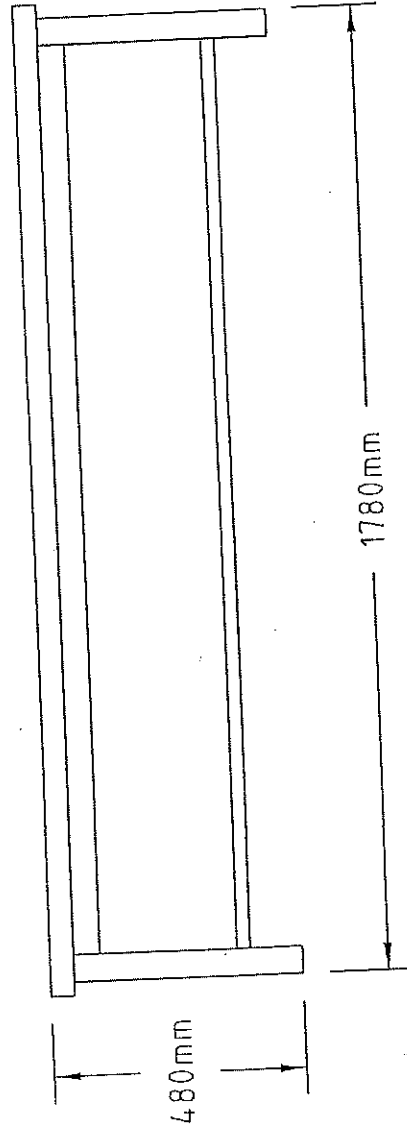

PANDANGAN HADAPAN

CATATAN:	SPESIFIKASI BAHAN		TARIKH	OLEH	SMK.
	SEMUA STRUKTUR DILAPISI "EPOXY"	KEPINGAN LOGAM 0.65/0.8/2.0MM			
UKURAN : W1830 X D350 X H480mm					1
					2
					3
					4
					5
TAJUK: SCHOOL BENCH (SB86)					
NO. LUKISAN: NO. FAIL:					
SKALA: B:BAS					

SCHOOL DINING / LIBRARY TABLE SDLT87

LAMPIRAN 46

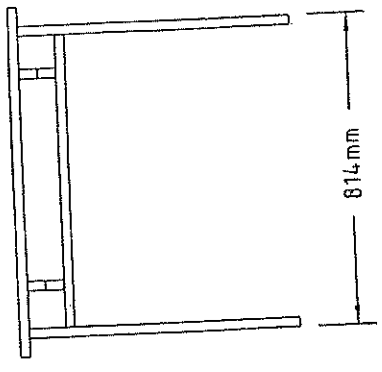
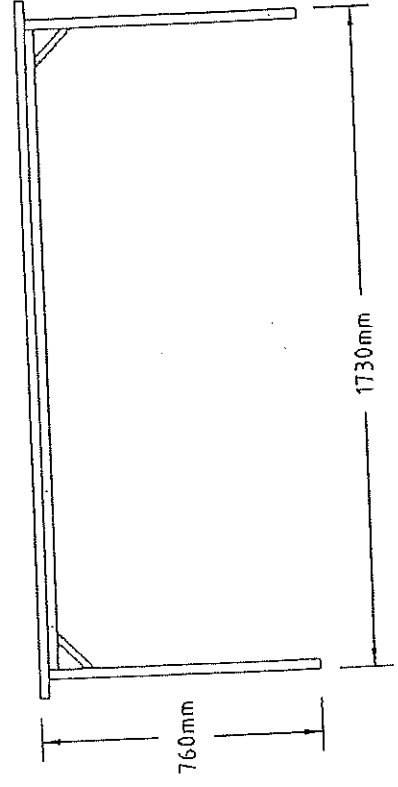
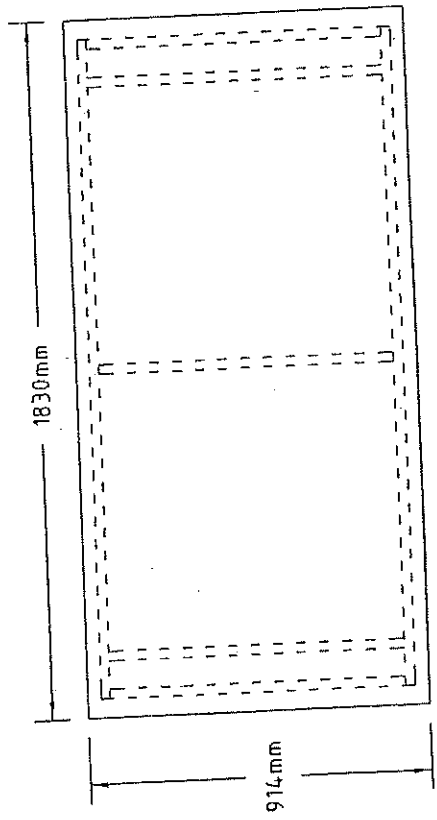

CATATAN:	SPESIFIKASI BAHAN		TARIKH	OLEH	SMK.
	1	2			
SEMUA STRUKTUR DILAPISI "EPOXY"	KEPINGAN LOGAM 0.65/0.8/2.0MM				1
					2
					3
					4
					5
UKURAN : W1830 X D914 X H760mm ANGGARAN +0.1 / -0.3					
TAJUK: SCHOOL DINING / LIBRARY TABLE (SDLT87)					
NO. LUKISAN:					
NO. FAIL:					
SKALA: BEBAS					

TUTORIAL CHAIR WITH TABLE
TCT91

LAMPIRAN 47

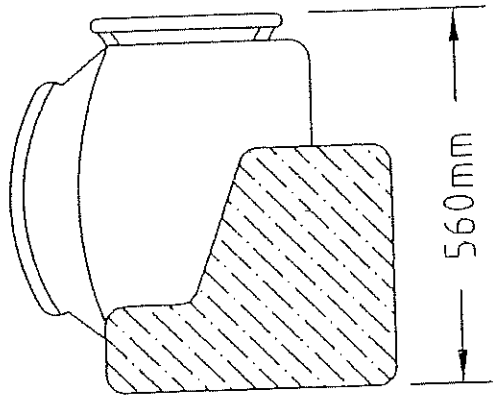

PANDANGAN ATAS

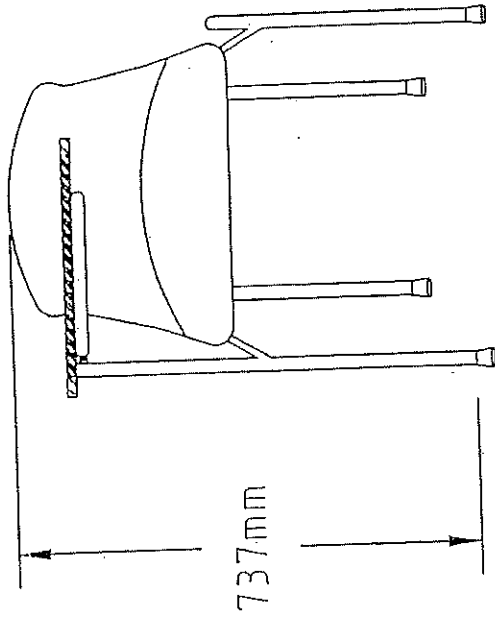

PANDANGAN HADAPAN

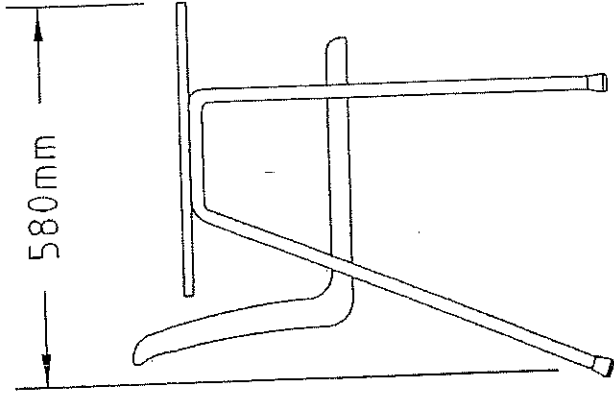

PANDANGAN SISI

CATATAN:	SPESIFIKASI BAHAN		TARIKH	OLEH	SMK.
	SEMUA STRUKTUR DILAPISI "EPOXY"	KEPINGAN LOGAM 0.65/0.8/2.0MM			
UKURAN : W560 X D580 X H737mm					1
					2
					3
					4
					5
TAJUK: TUTORIAL CHAIR WITH TABLE (TCT91)					
NO. LUKISAN: SKALA: BEBAS					
NO. FAIL: ANGGRAN +0.1 / -0.3					

STUDENT CHAIR
SCR92

LAMPIRAN 48

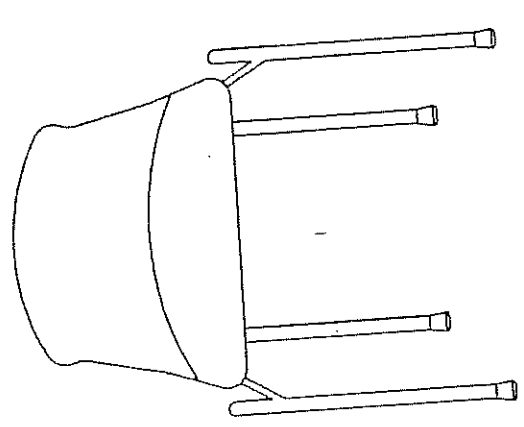

PANDANGAN HADAPAN

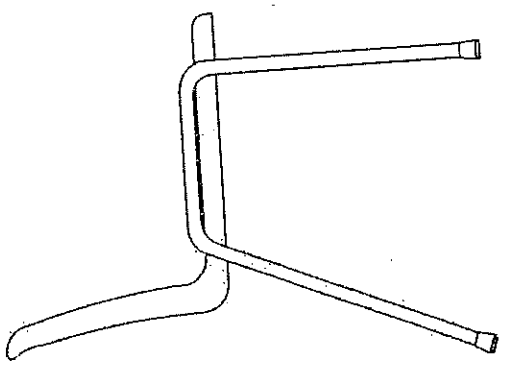

PANDANGAN SISI

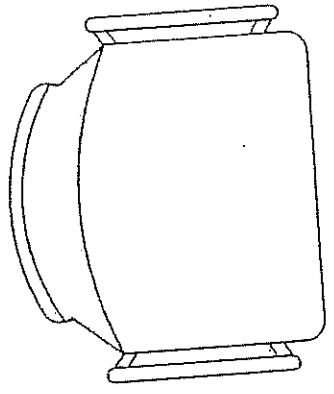

PANDANGAN ATAS

CATATAN:	SPESIFIKASI BAHAN		TARIKH	OLEH	SMK
	SEMUA STRUKTUR DILAPISI "EPOXY"	KEPINGAN LOGAM 0.65/0.8/2.0MM			
					1
					2
					3
					4
					5
TAJUK: STUDENT CHAIR (SCR92)					
NO. LUKISAN: NO. FAIL:					
SKALA: BEBAS					
ANGGAHAN +0.1 / -0.3					
CAT : POLYPROPYLENE SHELL LUBRICANT : MITSUBISHI ROUND TUBE					

KING SIZE BED
BB95

LAMPIRAN 49

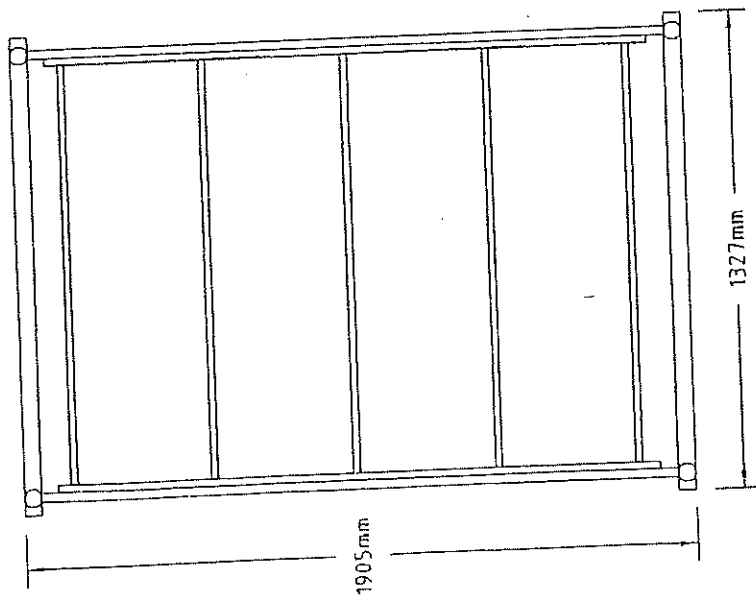

PANDANGAN ATAS

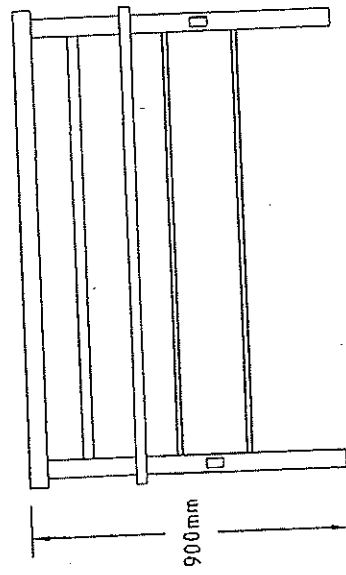

PANDANGAN DEPAN

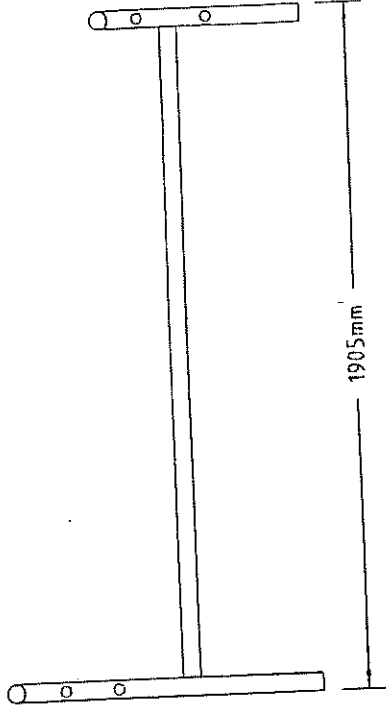

PANDANGAN SISI

CATATAN:	SPESIFIKASI BAHAN		TARIKH	OLEH	SMK.
	SEMUA STRUKTUR DILAPISI "EPOXY"	KEPINGAN LOGAM 0.65/0.8/2.0MM			
UKURAN : W1372 X D1905 X H900mm					1
					2
					3
					4
					5
TÁJUK: KING SIZE BED (BB95)					
NO. LUKISAN:					
NO. FAIL:					
SKALA: BELAS					
ANGGARAN +0.1 / -0.3					

STUDENT SINGLE BED c/w WIRE MESH SSB97

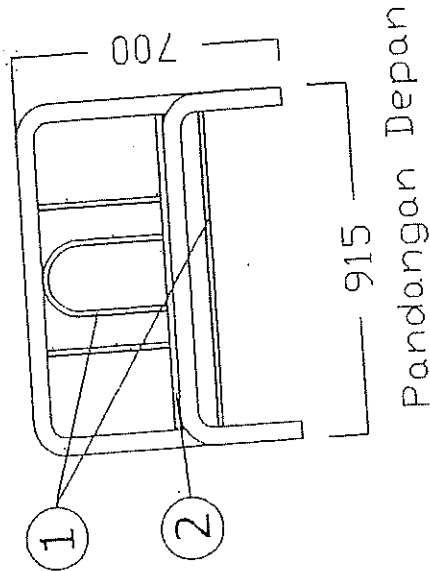
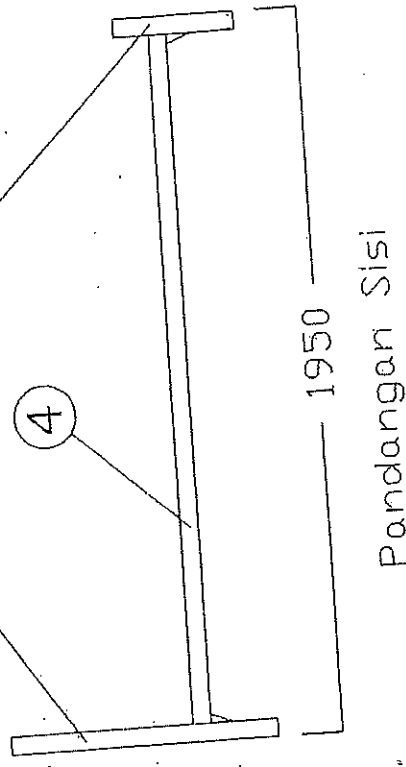
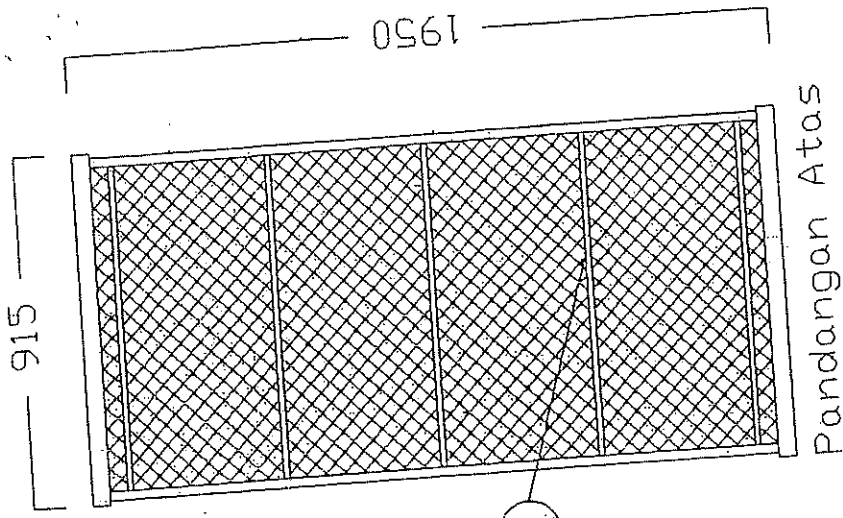

DATATAN:	SPESIFIKASI BAHAN:				
	TARIKH	OLEH	SMK	TAJUK :	
SEMUA STRUKTUR DILAPISI "EPDXY"	1		1	STUDENT SINGLE BED c/w	
	2		2	WIRE MESH	
	3		3	NO. LUKISAN :	
	4		4	NO. FAIL :	
	5		5	SKALA :	
UKURAN W915 X D1950 X H700 X 32M1	ANGGARAN 0.1/-0.3				

SINGLE BED c/w PLYWOOD BASE SB98

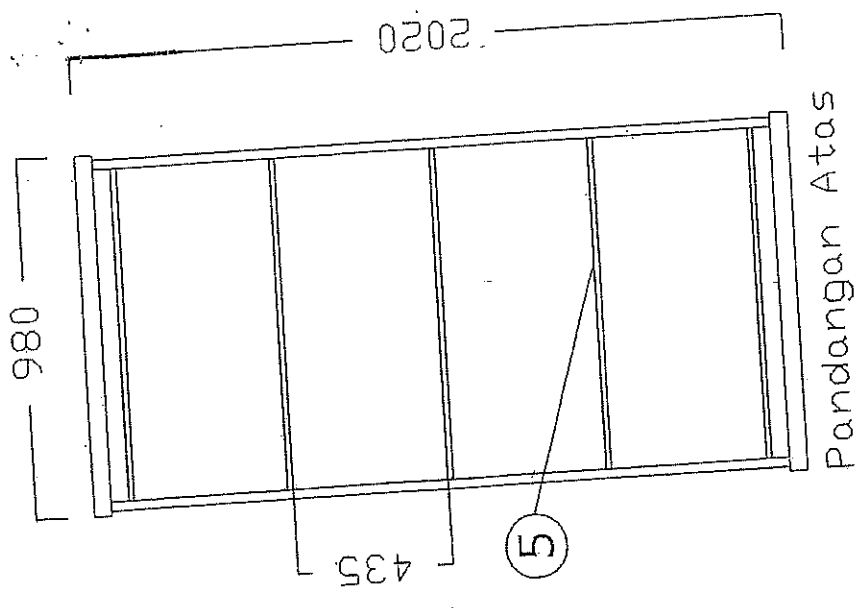
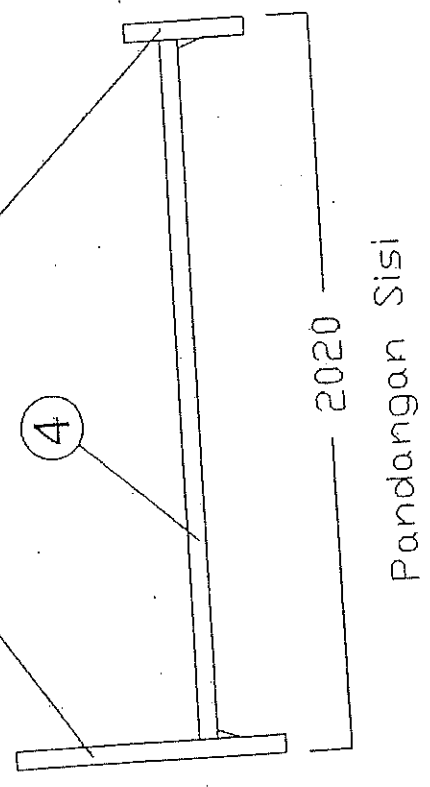
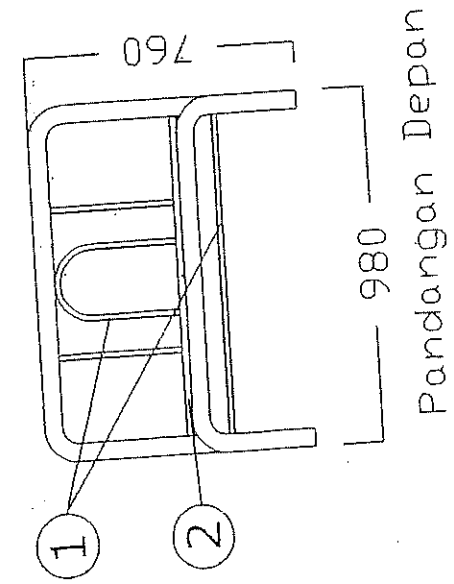

CATATAN:	SPESIFIKASI BAHAN:		TARIKH	OLEH	SMK
	SEMUA STRUKTUR DILAPISI "EPOXY"				
1- Round tiub 16 diameter 2- Round tiub 19 Diameter 3- Round tiub 50 Diameter 4- Rectangular Hollow Section 50 x 25mm 5- Square Hollow Section 16 X 16mm					1
					2
					3
					4
					5
TAJUK : SINGLE BED c/w PLYWOOD BASE					
SKALA : NO. LUKISAN : NO. FAIL :					
UKURAN 1980 X 2020 X H760 X 50MM ANGGARAN 0.1/-0.3					

DRESSING TABLE
DT100

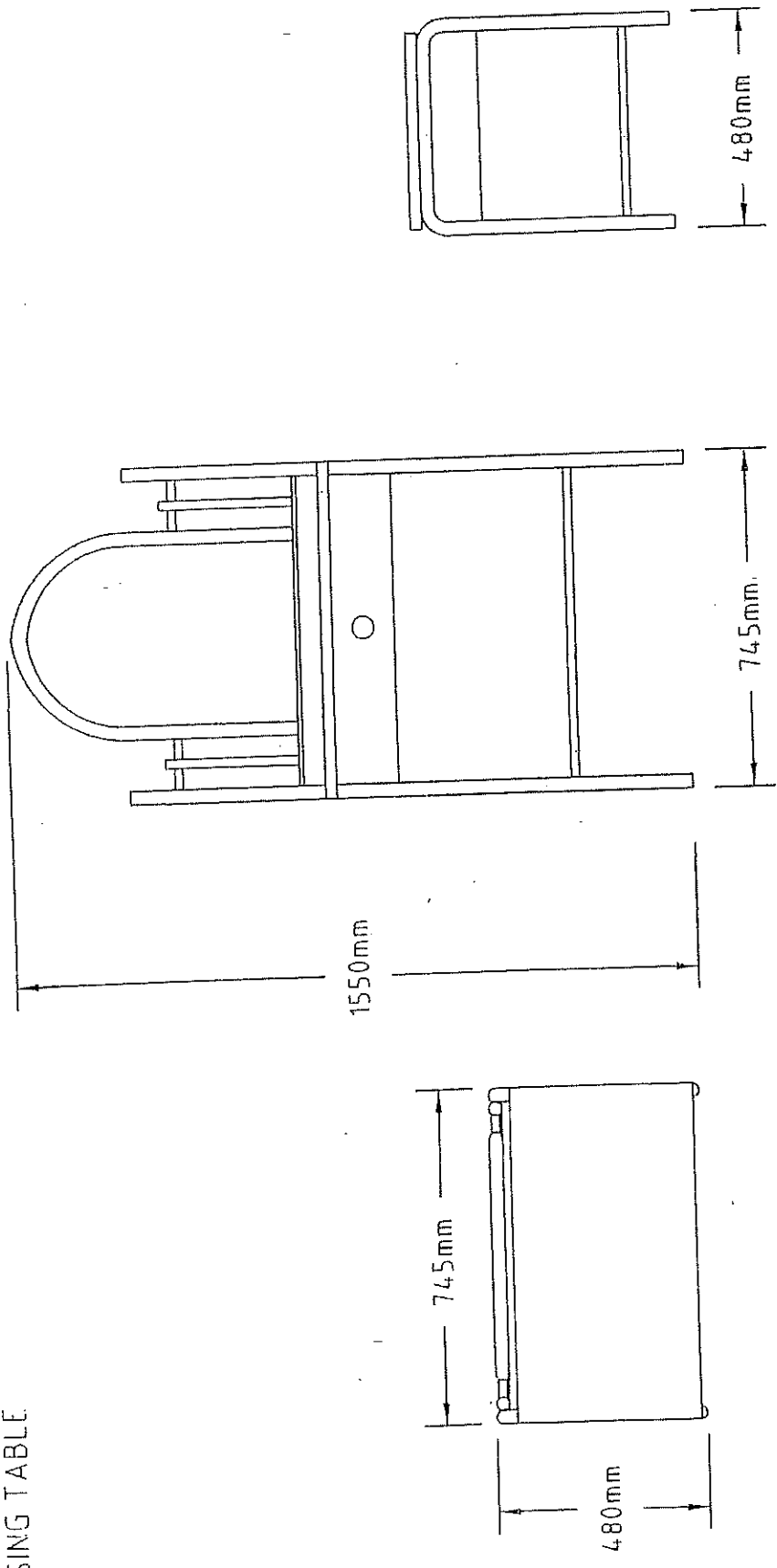

PANDANGAN SISI

PANDANGAN HADAPAN

PANDANGAN ATAS

CATATAN:	SPESIFIKASI BAHAN		TARIKH	OLEH	SMK.
	Kepingan Logam 0.65/0.8/2.0mm				
SEMUA STRUKTUR DILAPISI "EPOXY"					1
					2
					3
					4
					5
TAJUK: DRESSING TABLE (DT100)					
NO. LUKISAN:					
NO. FAIL:					
SKALA: BEBAS					
UKURAN : W745 X D480 X H1550mm					
ANGGARAN +0.1 / -0.3					

STUDENT DOUBLE DECKER BED C/W WIRE MESH

SDD102

LAMPIRAN 53

915

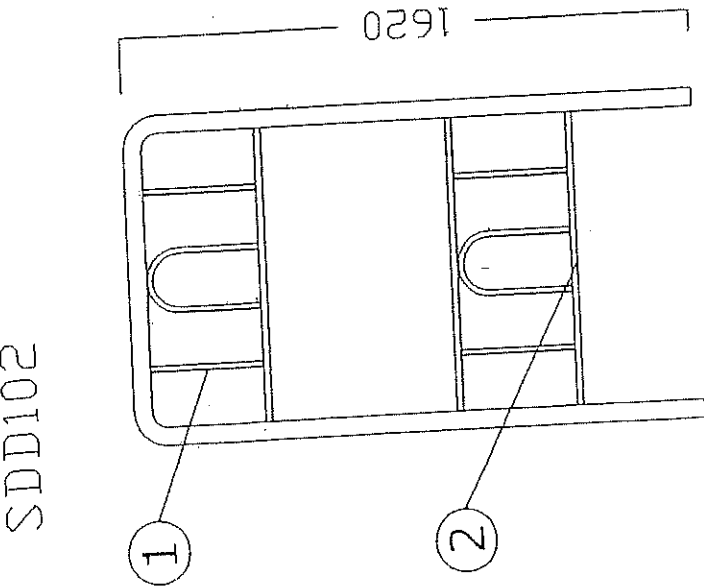

915

Pandangan Depan

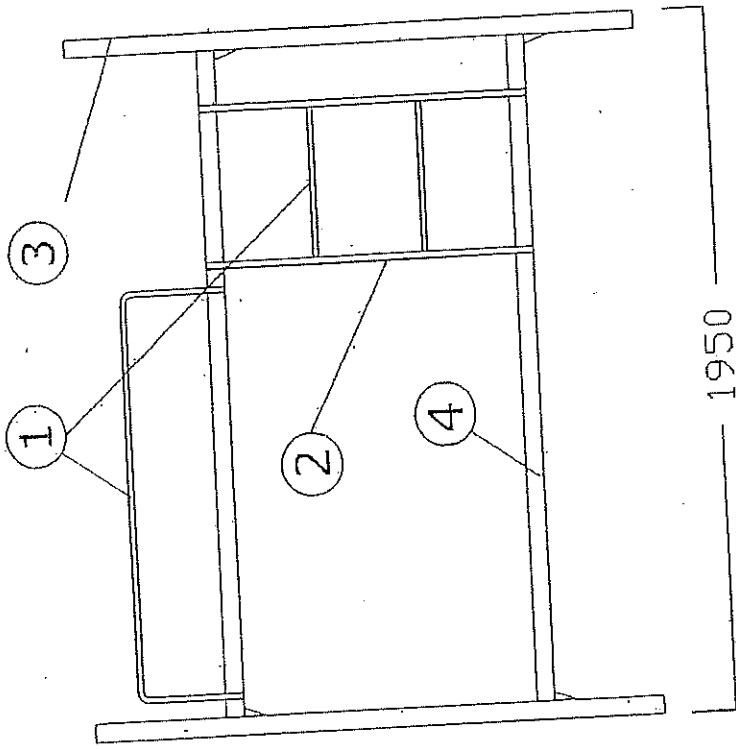

1950

Pandangan Sisi

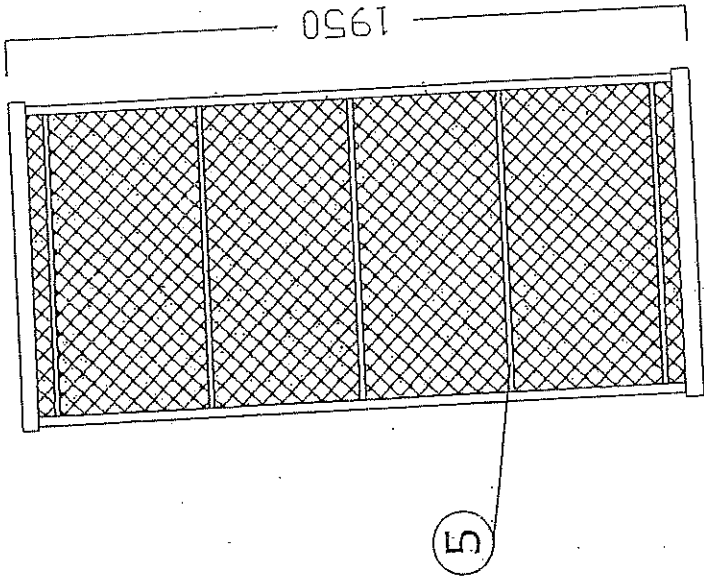

1950

Pandangan Atas

CATATAN:	SPESIFIKASI BAHAN:	TARIKH	OLEH	SMK	SKALA :	
					NO. LUKISAN :	NO. FAIL :
SEMUA STRUKTUR DILAPISI "EPDXY"	1-Round tiub 16 diameter 2-Round tiub 19 Diameter 3-Round tiub 32 Diameter 4-Rectangular Hollow Section 32 x 25mm 5-Square Hollow Section 16 X 16mm			1		TAJUK : STUDENT DOUBLE DECKER BED C/W WIRE MESH
				2		
				3		
				4		
				5		
UKURAN W915 X D1950 X H1620 X 32MM	ANGGARAN 0.1/-0.3					

DOUBLE DECKER BED c/w PLYWOOD BASE DD103

LAMPIRAN 54

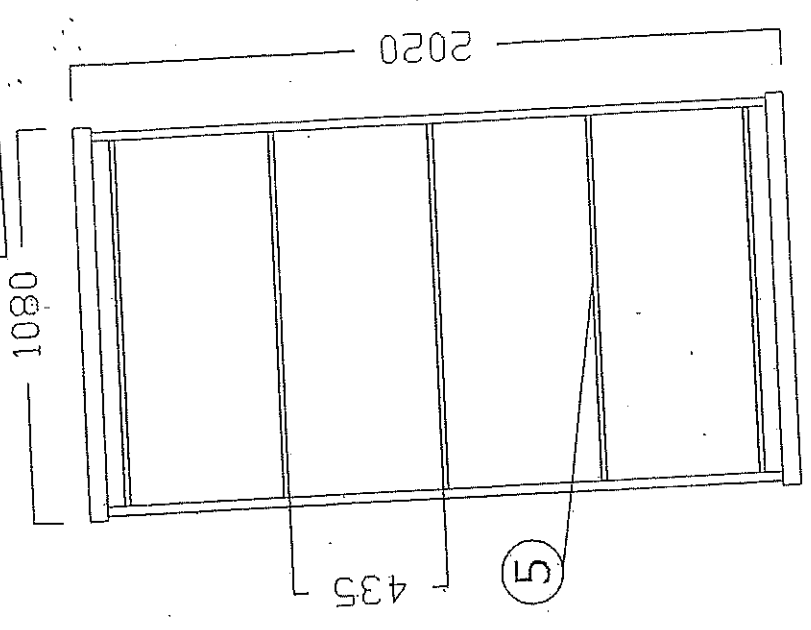

Pandangan Atas

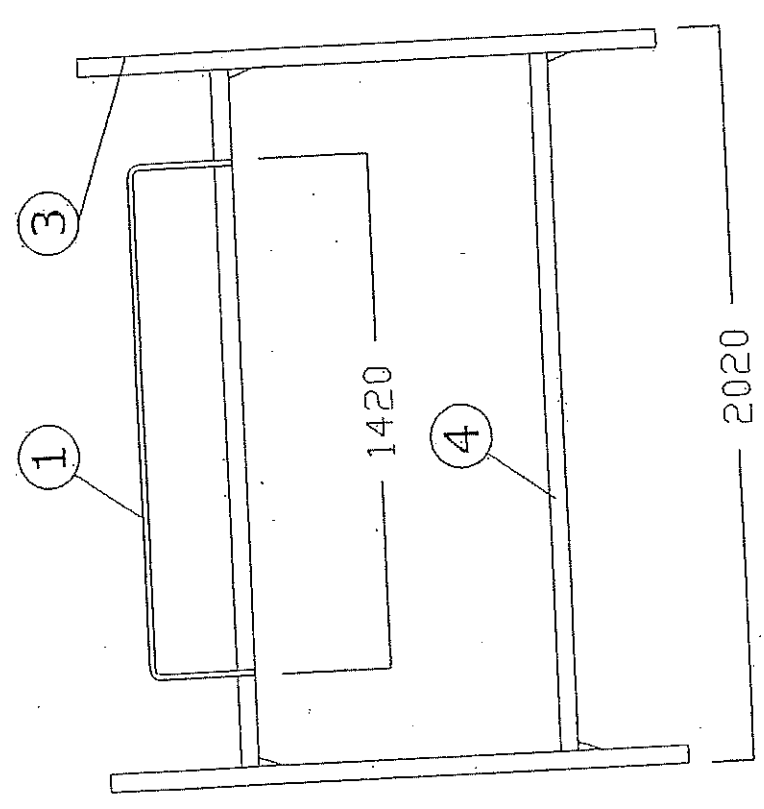

Pandangan Sisi

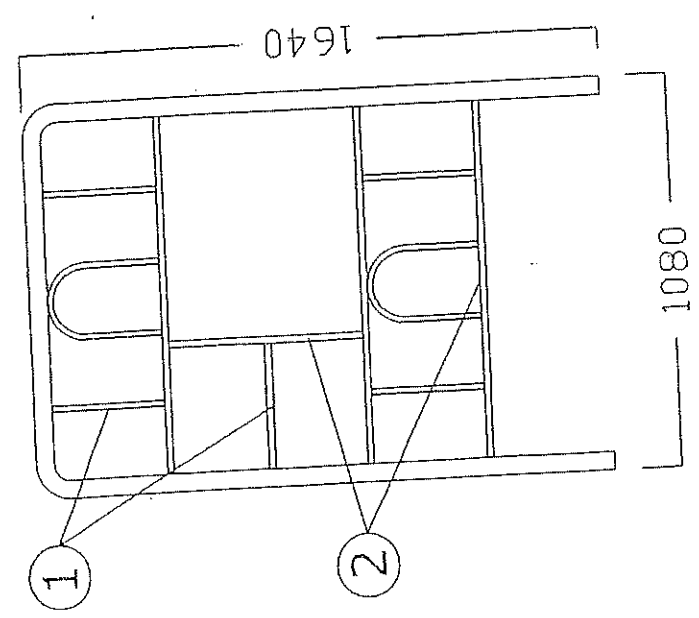

Pandangan Depan

CATATAN:	SPESIFIKASI BAHAN:	TARIKH	OLEH	SMK	TAJUK :	
					DOUBLE DECKER BED c/w PLYWOOD BASE	SKALA :
SEMUA STRUKTUR DILAPISI "EPOXY".	1-Round tiub 16 diameter 2-Round tiub 19 Diameter 3-Round tiub 50 Diameter 4-Rectangular Hollow Section 50 x 25mm 5-Square Hollow Section 16 X 16mm			1		
				2		
				3		
				4		
				5		
UKURAN W1080 X D2020 X H1640 X 50MM		ANGGARAN 0.1.-0.3		NO. LUKISAN : NO. FAIL :		